



中国·蓝波形象大使 董璇  
Brand spokesman

Dong Xuan  
董璇



LANBOO  
中国·蓝波

2022

PROFESSIONAL MANUFACTURE  
金属按钮专业制造商

让用电更安全  
Make Electricity Safer





**LANBOO**  
中国·蓝波

成为**开关行业**世界级的**引领者**

BECOME A WORLD-CLASS LEADER IN THE SWITCH INDUSTRY

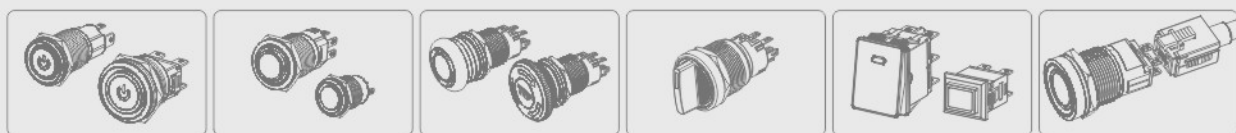

# 关于我们

## About Us

蓝波寓意：蓝图伟业，波澜壮阔。

在蓝色国土以及波涛汹涌的竞争环境下创造蓝海、绘制蓝图、建立丰功伟业。初步以电子、电器产品作为发展范围，前期以创造高品质、安全、精美、先进制造的为核心，以波澜壮阔的气势干实业。

LANBOO meaning: **Blueprint great cause, magnificent.**

Create blue oceans, draw blueprints, and build great achievements in a blue country and a turbulent competitive environment. Initially based on electronic and electrical products The scope of development, in the early stage, takes the creation of high-quality, safe, exquisite and advanced manufacturing as the core, and does the industry with a magnificent momentum.

蓝波品牌成立于2014年,是一家中国无区域化公司。主要研发、制造高端金属按钮开关、继电器、指示灯、急停开关、钥匙开关、旋钮、蜂鸣器、船型开关、触摸开关等产品,具备大电流、带灯、防水、防尘、防爆等功能,可定制开发。

申请100余项国家专利及发明专利,通过ISO9001质量管理体系认证,获得CE、SGS、CCC、CQC、RoHs、TUV、REACH、CB、UL61058等认证。首创各类7A、10A、16A、25A大电流金属按钮开关,引领前沿。在前进的路上我们坚持不断创新、创造、努力打造工匠产品。

拥有多年丰富经验的研发、精益生产、高水平管理、销售精英、法律维权等团队。拥有高端数控车间、自动化车间、数字化车间、ERP与PGS管理系统。确保高质、高效、优服务,努力打造精品蓝波品牌。通过努力已成为多家知名企业优秀合作伙伴,正泰集团ODM/OEM供应商,销售网络已覆盖全球。

注册LANBOO国际商标,走向全球。LANBOO蓝波注册国内全类商标,全面覆盖保护。

砥砺前行,我们再接再厉!

LANBOO brand was established in 2014 and is a non-regionalized company in China. Mainly develop and manufacture high-end metal button switches, relays, indicator lights, emergency stop switch, key switch, knob, buzzer, rocker switch, touch switch and other products, with high current, light, waterproof, dustproof, explosion-proof and other functions, Custom development is possible.

Apply for more than 100 national patents and invention patents, pass the ISO9001 quality management system certification, and obtain CE, SGS, CCC, CQC, RoHs, TUV, REACH, CB, UL61058 and other certifications. The first to create various types of 7A, 10A, 16A, 25A high-current metal button switches, leading the forefront. On the way forward we Adhere to continuous innovation, creation, and strive to create artisan products.

Has many years of rich experience in research and development, lean production, high-level management, sales elite, legal rights protection and other teams. Has a high-end CNC workshop, Automated workshop, digital workshop, ERP and PGS management system. To ensure high quality, high efficiency and excellent service, and strive to build a high-quality blue wave brand. achieved through effort As an excellent partner of many well-known enterprises, Chint Group is an ODM/OEM supplier, and its sales network has covered the world.

Register the LANBOO international trademark and go global. LANBOO has registered all kinds of domestic trademarks, covering all aspects of protection.

Forge ahead, we will make persistent efforts!

### 我们的愿景

Our Vision

## 成为开关行业世界级的引领者

Become a world-class leader in the switch industry

### 我们的使命

Our Mission

## 让用电更安全

Make electricity safer

### 核心价值观

Core Value

## —蓝波能得到全球的认可

—LANBOO Wave can be recognized worldwide

## —准确高效实现自我价值

—Accurately and efficiently realize self value

## —敢拼敢闯,成为了了不起的蓝波人

—Dare to fight and dare to be a great Lanboo person

### 质量方针

Quality Policy

## 工匠,做能感动自己的产品

Craftsmen, make products that can move you

## 创新,做认为不可能的事情

Innovate and do the impossible

## 俱进,走在超越世纪最前沿

Advance and walk in the forefront beyond the century

## 服务,付出追求爱人的热情

Service, pay the passion to pursue the lover





敢于创新/与众不同  
蓝波拥有100余项专利 多项认证



荣获“高新技术企业”  
为振兴民族品牌而不懈努力奋斗



让用电更安全  
安全大电流按钮开关



## 部分客户 Part Customers



排名不分先后

## 优胜劣汰的法则告诉我们：

只有品质和服务才是企业致胜的法宝  
所以我们将不遗余力的去持续改进, 尽善尽美!





**LANBOO**  
中国·蓝波

# 蓝图伟业, 波澜壮阔

乘风破浪的蓝波人勇往直前, 不负青春!



# 魅力蓝波 / 实力见证

CHARM LANBOO / STRENGTH WITNESS

十年磨一剑/厚积薄发/我们努力造精品





## 金属按钮、旋钮、钥匙钮、急停钮命名规则

LB $\diamond$ - $\star$  $\blacklozenge$  $\blacksquare$ / $\odot$  $\blacktriangle$  $\blacktriangledown$ / $\otimes$ / $\star$



- 例: 1. 需要16mm开孔、A系列、平头、1NO1NC、自锁、环形、红色发光、LED电压12V、镀铬外壳 对应型号:LB16A-P11Z/ER9-24V/N(L)  
 2. 需要22mm开孔、M5.1系列、蘑菇头、2NO2NC、自锁、不锈钢外壳 对应型号:LB22M5.1-M22Z/S(A(L))  
 3. 需要19mm开孔、X5系列、旋钮、1NO1NC、LED电压12V、红色发光,保持式、不锈钢外壳、2档 对应型号:LB19X5-X11Z/R5-24V/S/2(L)

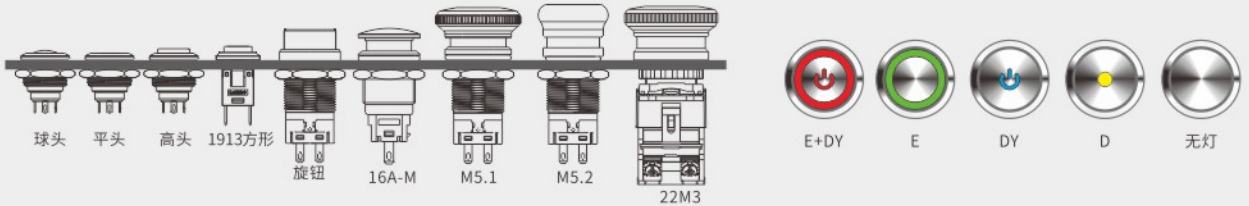

## 金属船型开关命名规则

LBCX $\square$ / $\star$  $\ast$  $\blacktriangle$  $\blacktriangledown$ / $\odot$

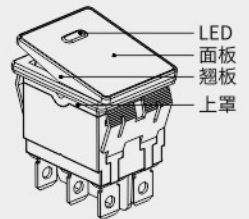

注: 开孔外形尺寸后面用“-”隔开,  $\ast$ 档、 $\blacktriangledown$ 带灯电压后面需要用“/”隔开; 不带灯的无需填写 $\blacktriangle$ 发光颜色、 $\blacktriangledown$ 带灯电压。  
 开关组合 1NO 和 1NC 只能做不带灯。

- 例: 28\*22外形、黑色面板、2NO、2档、蓝色、24V、镀铬上罩、 对应型号:LBCX2822/H2O2/B24V/N(L)

## 金属指示灯命名规则

LB $\diamond$ - $\star$ / $\odot$  $\blacktriangle$  $\blacktriangledown$ / $\otimes$ / $\bullet$



- 例: 直径12mm, 球头整面黄色发光, 12V, 铜镀铬材质 对应型号:LB12Z-Q/CY9-24V/N/150(L)



# 强大的研发能力

品种规格齐全，总有一款满足您的需求！

Variety specifications, there is always a suitable for you!

STRONG R&D Capability



**P01-03** 27.5X21继电器系列  
27.5X21 relay series



**P04** 12E迷你大电流开关  
12E Mini High-Current Button



**P05** 16E3迷你短款开关  
Mini Short-lag Current



**P06** 16B大电流开关  
16B High-Current Button



**P07** 19/22E短款大电流开关  
19/22E Short High-Current Button



**P08** 22/25C 15A大电流开关  
22/25C 15A High-Current Button



**P09** 2810.5船型开关  
2810.5 Roker switch



**P10** 2822船型开关  
2822 Roker switch



**P11** 1913大电流方形开关  
1913 15A High-Current Button



**P12-13** A系列金属按钮开关  
A Series Metal Button Switch



**P14** 19A1金属按钮开关  
19A1 Metal Button Switch



**P15** 12B/16E短款按钮  
12B 16E Short Button Switch



**P16** 22B/25B大电流开关  
22B/25B High-Current Button



**P17** 19/22CM大电流触摸开关  
19/22CM Touch Switch



**P18** 16-25超薄金属轻触开关  
16-25mm Tact Switch



**P19** 金属钮子开关  
Metal Toggle Switch



**P20** 金属旋钮开关  
Metal Knob Switch



**P21** 新款钥匙钮  
New Key Switch



**P22** 带灯急停  
Stop Button with LED



**P23** 无灯急停  
Emergency Button



**P24** 6-25mm信号灯系列  
6-25mm Indicator Light



**P25** 8mm高亮指示灯  
Bright Indicator Light



**P26** 闪光蜂鸣器  
Buzzer



**P27** 2系列经济款  
Economic Series



**P28** 塑料按钮开关  
Plastic Switch



**P29** 定制开发系列  
Customization



**P30** 光电开关  
Saf Button Switch



**P31-34** 高端塑料开关  
Plastic Switch



**P35-37** 组合式按钮开关  
Combined Button



**P38** 附件系列  
Accessories Series



**P39** 螺母扳手  
Nut Wrench



**P40** 保护盖  
Safety Shield



# 继电器系列

Intermediate Relay Series

## LB27.5X21

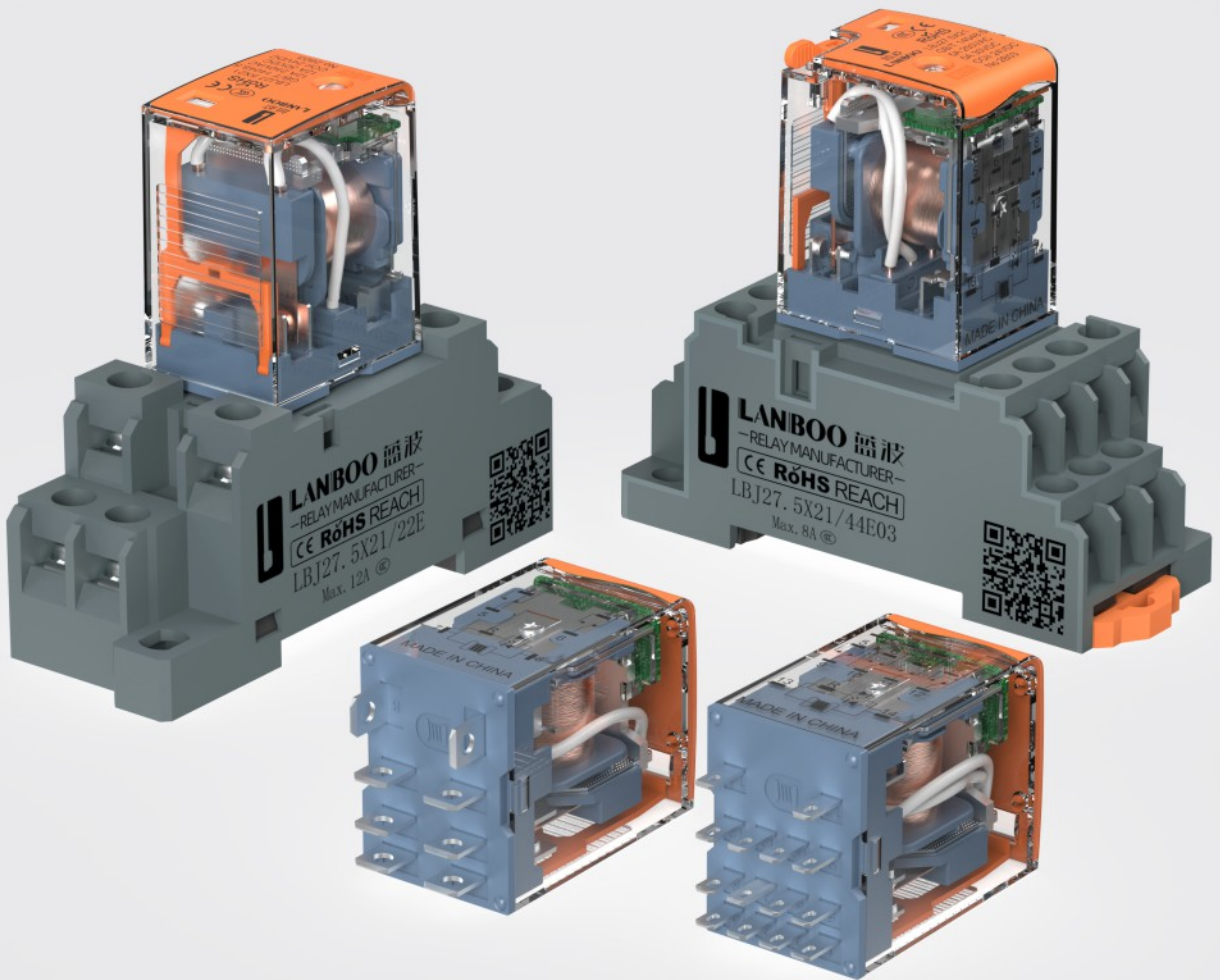

≤ 50mΩ  
接触电阻  
Contact Resistance



1000MΩ  
绝缘电阻  
Insulation Resistance



50000H  
长寿命灯珠  
Long Life LED



2000万次  
机械寿命  
Mechanical Life



V2  
耐温阻燃  
Anti-f Laming



-40~80°C  
温度范围  
Environment



CCC RoHS REACH CE  
专利及认证  
Certificate



**DC 直流** LED灯通电状态为绿色  
Power-On status is green



**AC 交流** LED灯通电状态为红色  
Power-On status is red

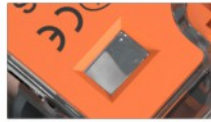

1. 未显示状态  
Not Shown



2. 未切换触点状态  
Unswitched Contact

常开常闭未切换前的状态  
State Before Switching



1. 显示状态  
Display State



2. 切换触点状态  
Changeover Contact

常开常闭切换后的状态  
State After Switching

大8角(12A)  
2NO 2NC

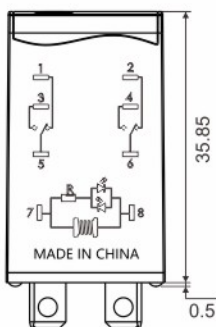
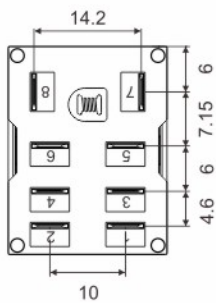

小8角(12A)  
2NO 2NC

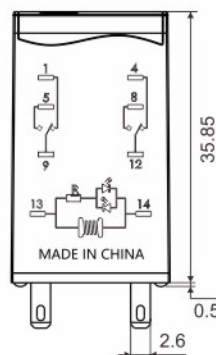
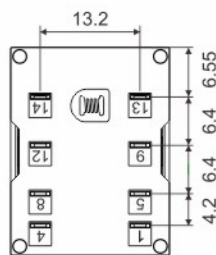

小14角(5A)  
4NO 4NC

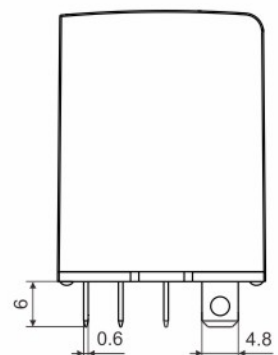
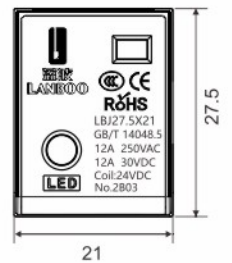
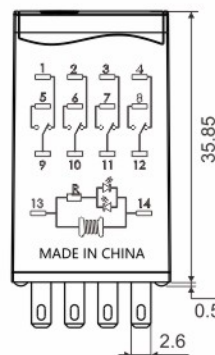
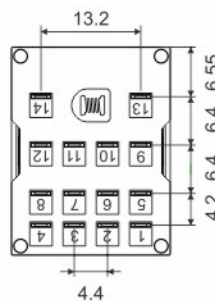



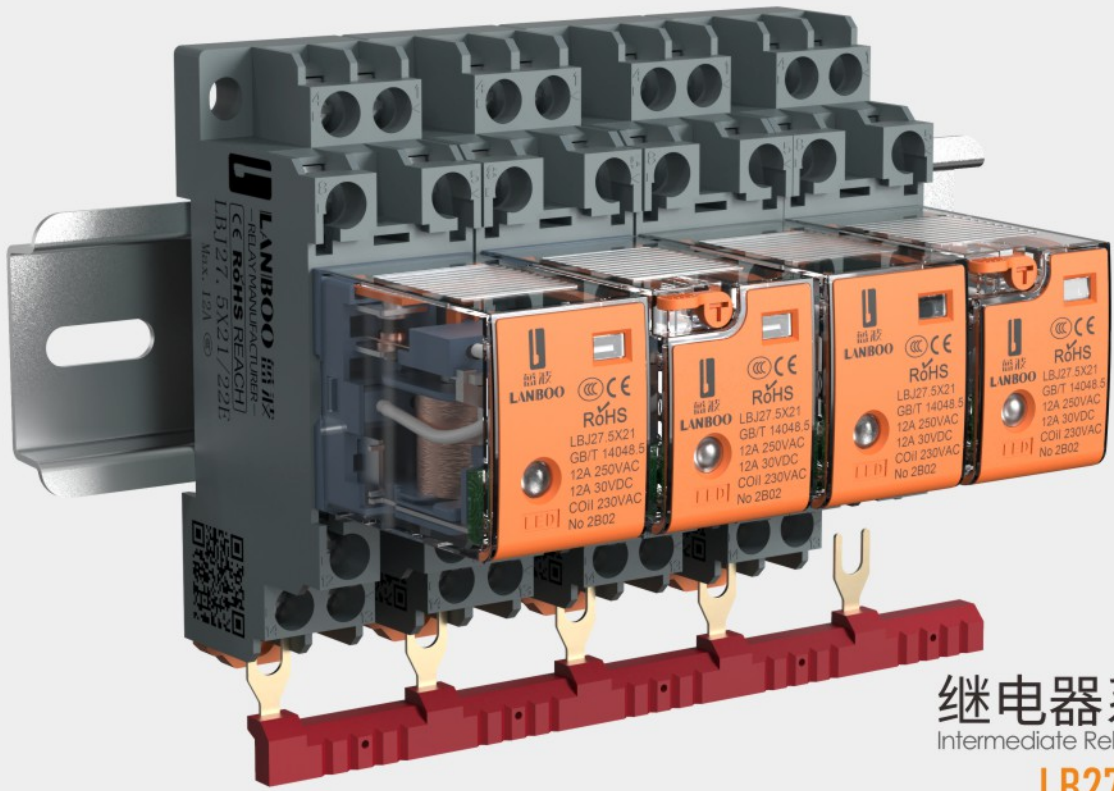

## 继电器系列

Intermediate Relay Series

### LB27.5X21

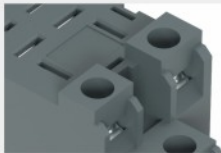

带翼设计  
Winged Design



阻燃耐温外壳  
Flame Retardant

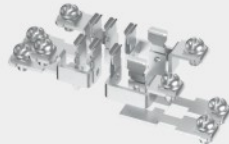

加厚插簧  
Thickened Spring



导轨式卡扣  
Rail type Buckle

大8脚小14脚底座专用  
Large 8-Pin, small 14-Pin base jumper

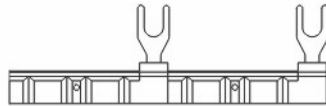

间距29mm

小8脚底座专用  
Small 8-Pin base jumper

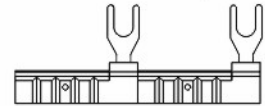

间距22mm

Blue Red Black 三种颜色可选, 间距29mm及22mm二种规格可选, 可根据需求裁剪任意长度, 一根的规格为10个端头。

Three colors are available, there are two specifications of 29mm and 22mm distance, which can be cut according to demand. One piece is 10 ends.

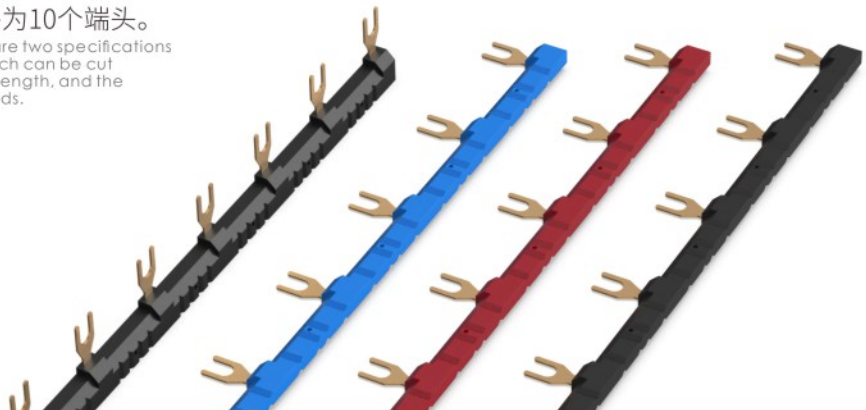

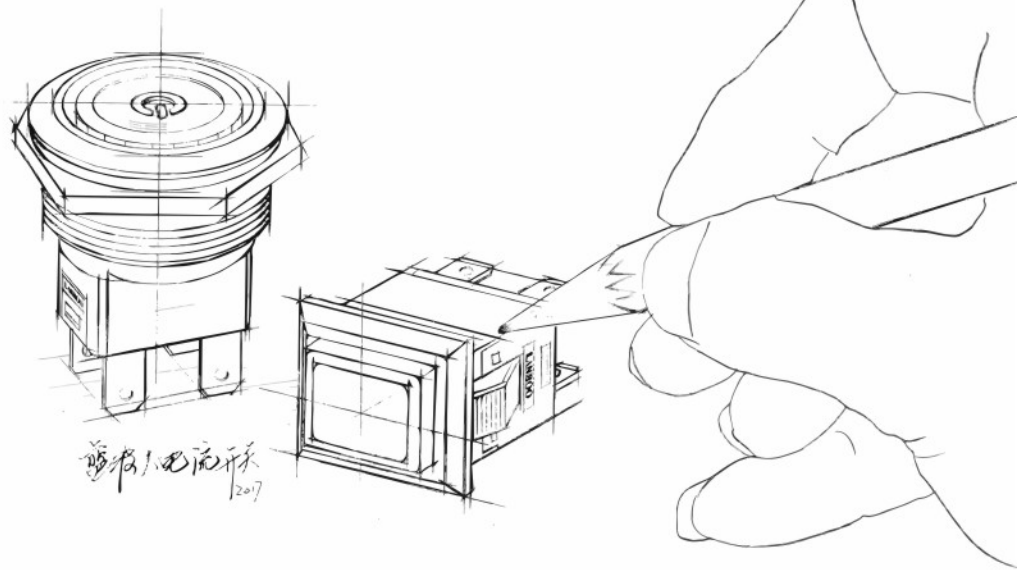

# 安全大电流按钮开关

Safe & High-Current Push Button Switch



12E/7A Series

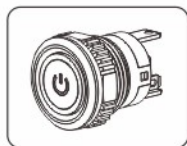

16E3/20A Series

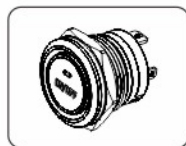

19E/15A Series



22C/15A Series

一直被模仿,从未被超越

We've been imitated, But never beyond



# LB12E High Current

## 迷你大电流金属按钮

Mini High-Current Button Switch  
Ith: 10A 250VAC

1NO



低功耗LED: ≤20mA  
Low Power Consumption LED: ≤20mA  
常规电压: 5-24V 220V, 定制其它电压  
Normal Voltage: 5-24V 220V, Customizable Other Voltage  
常规颜色: 红色、绿色、蓝色; 定制: 黄色、白色  
Normal Color: Red/Green/Blue; Customizable: Yellow/White

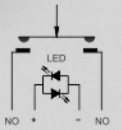

- 10A**  
Ith  
大电流开关  
High-Current
- 2500VAC**  
高绝缘耐压  
High-Insulation
- LED**  
50000H  
长寿命灯珠  
Long Life LED
- 100万次**  
机械寿命  
Mechanical Life
- VO**  
耐高温阻燃  
AntiFl Laming
- 40~80°C**  
环境耐温强  
Environment
- IP67/IK08**  
防水防爆  
Protection Level
- CCC RoHS REACH CE**  
专利及认证  
Certificate



凹面头部,方便按压  
Concave Head



配套插件  
Connector



镀金镀银插脚  
Gold/Silver Plated Pins



高亮均匀发光  
Even and Soft LED

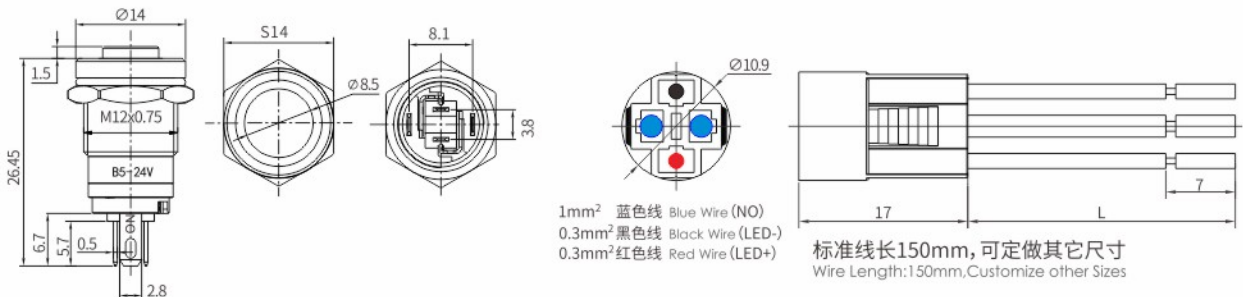

# LB16E3 Short Large current

## 迷你短款大电流金属按钮

Mini Short-lagre Current Button Switch  
Ith:20A 250VAC

1NO



低功耗LED: ≤20mA  
Low Power Consumption LED: ≤20mA  
常规电压: 5-24V 220V, 定制其它电压  
Normal Voltage: 5-24V 220V, Customizable Other Voltage  
常规颜色: 红色、绿色、蓝色; 定制: 黄色、白色  
Normal Color: Red/Green/Blue; Customizable: Yellow/White

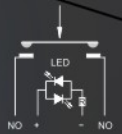

20A  
Ith  
大电流开关  
High-Current



短  
23mm  
短款设计  
Short Design



4000米  
适合海拔  
Long Life LED



50万次  
机械寿命  
Mechanical Life



V0  
连接端耐温阻燃  
Antif Laming



-40~80°C  
抗耐温范围  
Environment



IP66/IK08  
防水防尘  
Protection Level



CCC RoHS REACH  
专利及认证  
Certificate



凹面头部方便按压  
Concave Head



配套插件  
Connector



镀银长插脚  
Silver Long Plated Pins



高亮均匀发光  
Even and Soft LED



短脚无接插件  
Short pin without connector

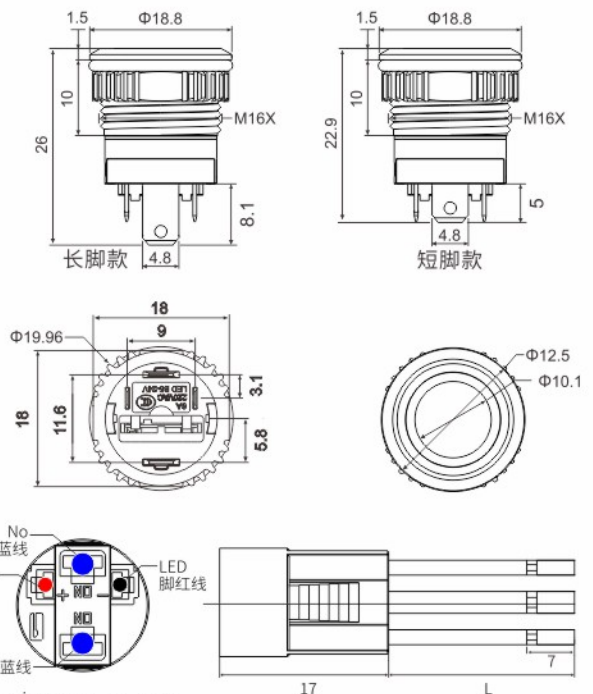

1mm<sup>2</sup> 蓝色线 Blue Wire (NO)  
0.3mm<sup>2</sup> 黑色线 Black Wire (LED-)  
0.3mm<sup>2</sup> 红色线 Red Wire (LED+)

标准线长150mm, 可定做其它尺寸  
Wire Length: 150mm, Customize other Sizes



# LB16B/19B High Current

## 大电流金属按钮开关

High-Current Button Switch

Ith:15A 250VAC

1NO

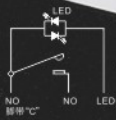

- 无灯  
Without
- 环形灯  
Ring LED
- 环形+电源  
Ring+Power Symbol

- 红色  
Red
- 绿色  
Green
- 蓝色  
Blue
- 黄色  
Yellow
- 白色  
White

低功耗LED: ≤20mA

Low Power Consumption LED: ≤20mA

常规电压: 9-24V 220V, 定制其它电压

Normal Voltage: 9-24V 220V, Customizable Other Voltage

常规颜色: 红色、绿色、蓝色; 定制: 黄色、白色

Normal Color: Red/Green/Blue; Customizable: Yellow/White



15A

Ith

大电流开关  
High-Current



1500VAC

高绝缘耐压  
High-Insulation



LED

50000H

长寿命灯珠  
Long Life LED



100万次

机械寿命  
Mechanical Life



V0

耐高温阻燃  
Anti Flaming



-40~80°C

环境耐温强  
Environment



IP65/IPK10

防水防爆  
Protection Level



CCC RoHS REACH CE

专利及认证  
Certificate



柔光光圈, 长寿命LED  
Soft Light Aperture



高精数控, 精致美观  
Seiko CNC



专用插件, 阻燃耐温  
Connector



加大银触点, 粗脚, 电流大  
Big Silver Contact

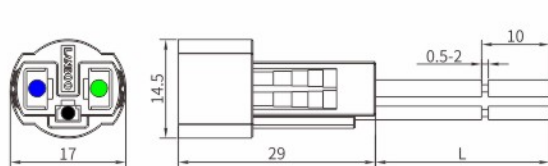
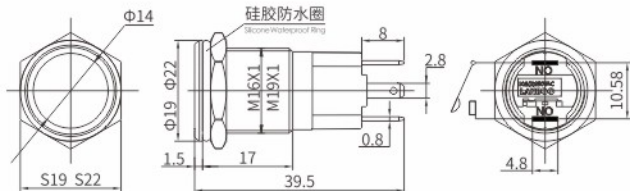

● 蓝色和 ● 绿色NO线为1mm<sup>2</sup>, ● 黑色灯脚线0.5mm<sup>2</sup>, 线长150mm, 可定做其它线长。

Blue and Green NO wire 1mm<sup>2</sup>, Black LED wire 0.5mm<sup>2</sup>, Wire Length: 150mm, Customize other sizes.

# LB19E/22E Short 短款

## 大电流金属按钮开关

High-Current Short Switch

Ith:20A 250VAC

1NO

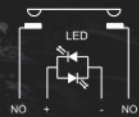

红色 Red    绿色 Green    蓝色 Blue    黄色 Yellow    白色 White

低功耗LED: ≤20mA

Low Power Consumption LED

常规电压: 5-24V 220V, 定制其它电压

Normal Voltage: 5-24V 220V, Customizable Other Voltage

常规颜色: 红色、绿色、蓝色; 定制: 黄色、白色

Normal Color: Red/ Green/ Blue; Customizable: Yellow/ White



20A

Ith

大电流开关  
High-Current

2500VAC

高绝缘耐压  
High-Insulation

LED

50000H  
长寿命灯珠  
Long Life LED

100万次

机械寿命  
Mechanical Life

V0

耐高温阻燃  
Anti-Laming

-40~80°C

环境耐温强  
Environment

IP67/IK10

防水防爆  
Protection Level

CCC RoHS REACH CE

专利及认证  
Certificate



凹面大按键, 贴合手指  
Easy to Press



无极LED灯珠, 大触点  
Non-Polar LED



加粗镀金脚, 可拆锁钩  
Thick Gold Plated



专用接插件  
Connector

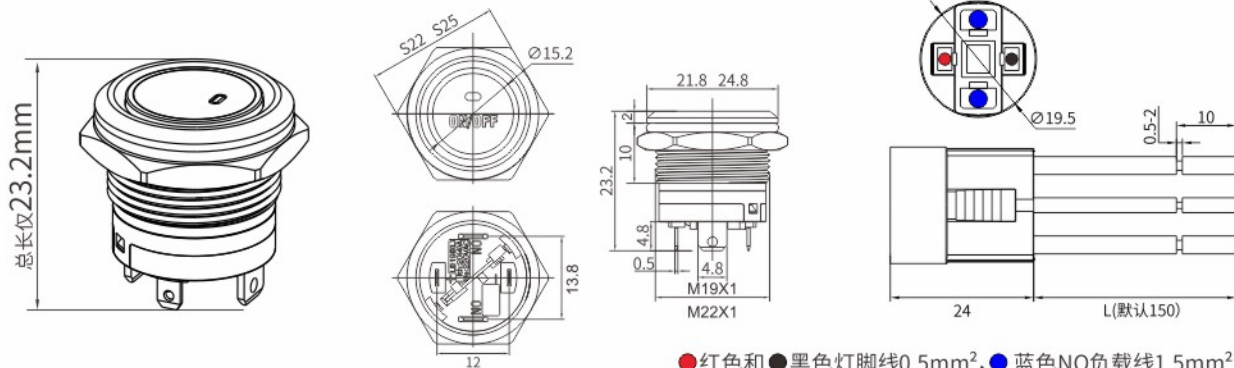

● 红色和● 黑色灯脚线0.5mm<sup>2</sup>, ● 蓝色NO负载线1.5mm<sup>2</sup>  
线长150mm, 可定做其它线长  
Red and Black LED wire 0.5mm<sup>2</sup>, Blue NO wire 1.5mm<sup>2</sup>  
Wire Length: 150mm, Customize other sizes.



# LB22 / 25C High Current

## 大电流金属按钮开关

High-Current Button Switch

Ith: 20A 250VAC

### 2NO



无灯 环形灯 环形+电源  
Without Ring LED Ring+Power Symbol



红色 绿色 蓝色 黄色 白色  
Red Green Blue Yellow White

低功耗LED: ≤20mA

Low Power Consumption LED: ≤20mA

常规电压: 9-24V 220V, 定制其它电压

Normal Voltage: 9-24V 220V, Customizable Other Voltage

常规颜色: 红色、绿色、蓝色; 定制: 黄色、白色

Normal Color: Red/Green/Blue; Customizable: Yellow/White



20A

Ith

大电流开关  
High-Current



3000VAC

高绝缘耐压  
High-Insulation



50000H

长寿命灯珠  
Long Life LED



100万次

机械寿命  
Mechanical Life



V0

耐阻燃  
Anti Flaming



-40~80°C

环境耐温强  
Environment



IP67/IPK10

防水防爆  
Protection Level



CCC RoHS REACH CE CB  
专利及认证  
Certificate



凹面设计, 贴合手指  
Concave Design/Easy to press



加粗镀银插脚, 大电流  
Bold Silver plated Pins, High-Current



可配插件, 塑料件均阻燃  
Connector

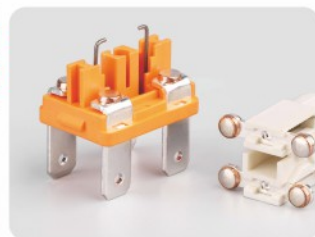

加大银点, 双锁钩  
Bold Silver Contact

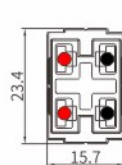
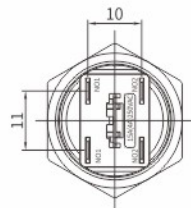
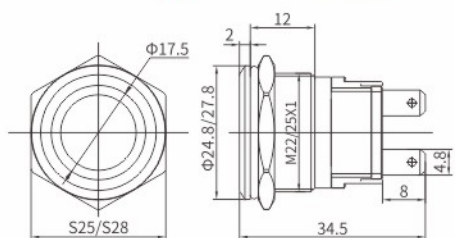

线长默认150mm, 1.5mm<sup>2</sup>, 可做其它线长  
Wire Length: 150mm, 1.5mm<sup>2</sup> Customize other Sizes

# LBCX2810.5 Roker 船型

## 大电流金属KCD3

High-Current KCD3

Ith: 20A 250VAC

### 2NO

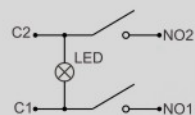

LED发光颜色 LED Color  
面板颜色 Panel Color

低功耗LED:  $\leq 20\text{mA}$

Low Power Consumption LED:  $\leq 20\text{mA}$

常规电压: 9-24V 220V, 定制其它电压

Normal Voltage: 9-24V 220V, Customizable Other Voltage

常规颜色: 红色、绿色; 定制: 蓝色、黄色、白色

Normal Color: Red / Green; Customizable: Blue / Yellow / White

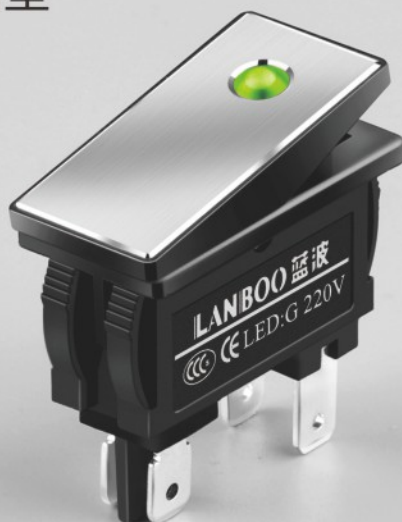

20A

Ith

大电流开关  
High-Current



3000VAC

高绝缘耐压  
High-Insulation



6063

铝氧化面板  
Aluminum Oxidized



LED

50000H  
长寿命灯珠  
Long Life LED



20万次

机械寿命  
Mechanical Life



V0

耐高温阻燃  
Anti-f Laming



-40-80°C

环境耐温强  
Environment



CCC RoHS REACH CE  
专利及认证  
Certificate



铝切割面板, 高亮面边框  
Aluminum Cutting panel



加粗镀银插脚, 触点, 大电流  
Bold Silver Plated Pins, High-Current

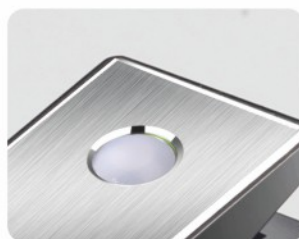

带指示灯  
LED



请认准“蓝波”  
LANBOO BUTTON

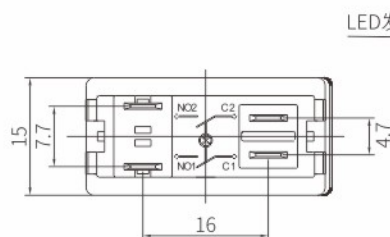
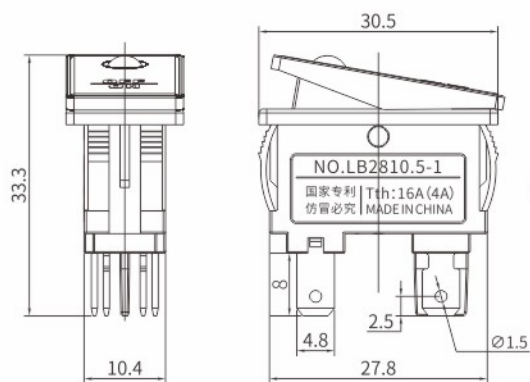

LED发光指示

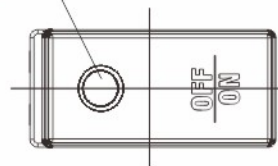



# LBCX2822 Roker 船型

大电流金属KCD4  
High-Current KCD4  
Ith:20A 250VAC  
2NO2NC

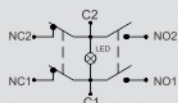

土豪金 Gold  
天山银 Silver  
绚丽黑 Black  
面板颜色 Panel Color

低功耗LED: ≤20mA

Low Power Consumption LED: ≤20mA

常规电压: 9-24V 220V, 定制其它电压

Normal Voltage: 9-24V 220V, Customizable Other Voltage

常规颜色: 红色、绿色; 定制: 蓝色、黄色、白色

Normal Color: Red/ Green; Customizable: Blue/Yellow/White



20A

Ith

大电流开关  
High-Current



3000VAC

高绝缘耐压  
High-Insulation



6063

铝氧化面板  
Aluminium Oxidized



LED

50000H  
长寿命灯泡  
Long Life LED



20万次

机械寿命  
Mechanical Life



V0

耐阻燃  
Antiflaming



-40-80°C

环境耐温强  
Environment



CCC RoHS REACH

专利及认证  
Certificate



2822-1

1. 金属面板
2. 镀铬翘板
3. 镀铬上罩
4. 优质尼龙

1. Metal panel
2. Chrome-Plated
3. Chrome
4. PA66



2822-2

1. 金属面板
2. 塑料翘板
3. 塑料上罩
4. 一般尼龙

1. Metal panel
2. Plastic
3. Plastic
4. General nylon



2NO触点

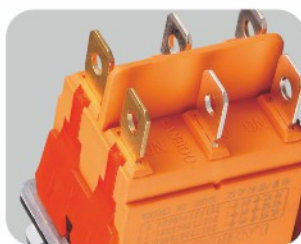

2NO2NC触点

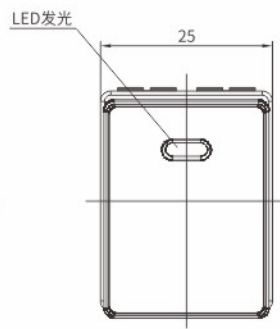
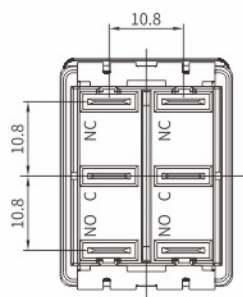
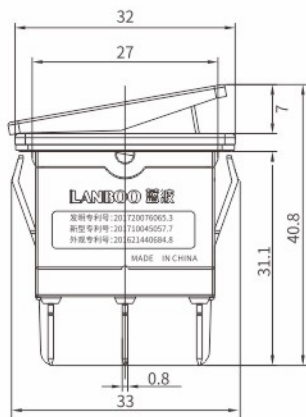
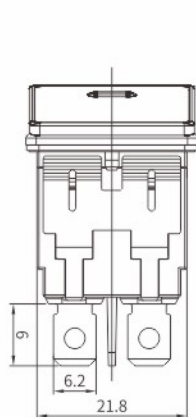

# LB1913 Square Button

方形按钮

方形大电流金属按钮

Square High-Current Button

Ith:20A 250VAC

2NO

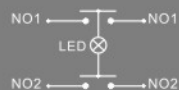

低功耗LED: ≤20mA  
Low Power Consumption LED: ≤20mA  
常规电压: 9-24V 220V, 定制其它电压  
Normal Voltage: 9-24V 220V, Customizable Other Voltage  
常规颜色: 红色、绿色、蓝色; 定制: 黄色、白色  
Normal Color: Red/Green/Blue; Customizable: Yellow/White

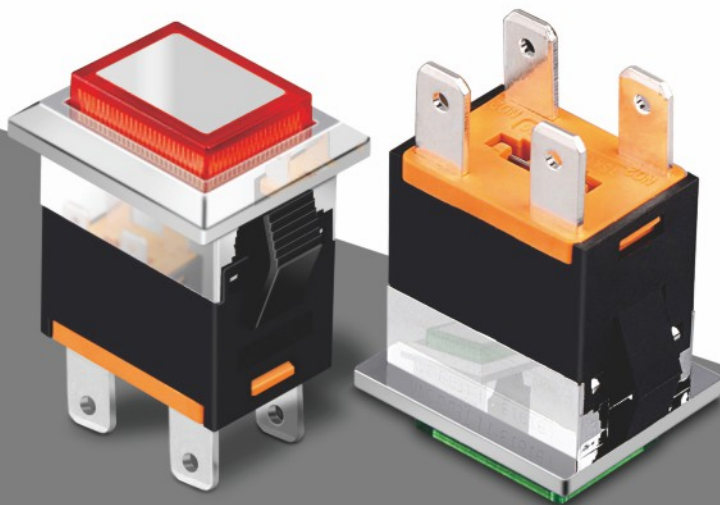

20A

Ith

大电流开关  
High-Current



3000VAC

高绝缘耐压  
High-Insulation



304

不锈钢按钮  
Stainless Steelkey



LED

50000H  
长寿命灯珠  
Long Life LED



20万次

机械寿命  
Mechanical Life



V0

耐高温阻燃  
Anti Flaming



-25-55°C

环境耐温强  
Environment



RoHS REACH CE  
专利及认证  
Certificate

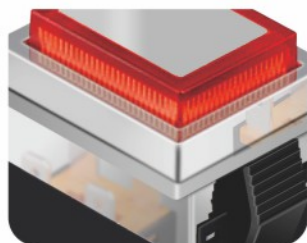

不锈钢按钮, 镀铬头部  
Stainless Steel Key



加粗镀银插脚  
Silver Plated Pins

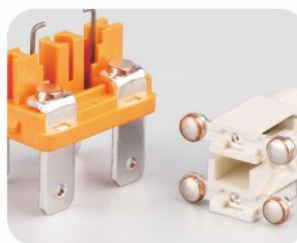

4颗加粗银触点  
Silver Contact



专用接插件  
Connector

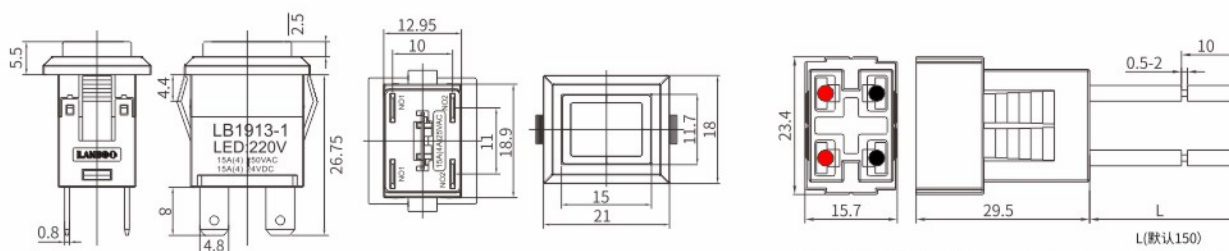

接插件线长默认150mm, 1.5mm<sup>2</sup>, 可做其它线长  
Wire Length: 150mm, 1.5mm<sup>2</sup> Customize other Sizes



# LB16-40A Series

Monochrome/Bi-color/Tri-color LED  
IP67/可做双色、三色发光

**1NO1NC / 2NO2NC**

Ith:5A 250VAC

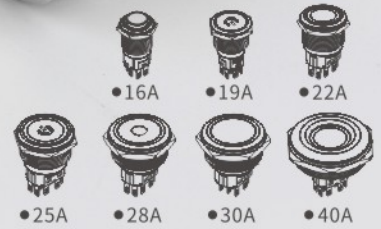
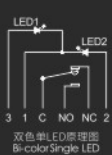
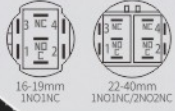

**RGB**  
可做双色三色  
Bi-color/Tri-color



**<50mΩ**  
快动高灵敏  
Contact sensitive



**50000H**  
长寿命灯珠  
Long Life LED



**100万次**  
机械寿命  
Mechanical Life



**V0**  
耐温阻燃  
Anti-laminar



**-40-80°C**  
环境耐温强  
Environment



**IP67/IK10**  
防水防爆  
Protection Level



**CCC RoHS REACH CE TUV CE<sub>ROHS</sub> CB<sub>ROHS</sub>**  
专利及认证  
Certificate



•16A(16mm)



•19A(19mm)



•22A(22mm)



•25A(25mm)



•28A(28mm) •30A(30mm)



•40A(40mm)



# 高亮无极宽电压LED LongLife/Wide Voltage LED

低功耗LED: ≤20mA  
Low Power Consumption LED: ≤20mA

常规电压: 9-24V 220V, 定制其它电压  
Normal Voltage: 9-24V 220V, Customizable Other Voltage

常规颜色: 红色、绿色、蓝色; 定制: 黄色、白色、双色、三色  
Normal Color: Red/Green/Blue; Customizable: Yellow/White/Bi-color/Tri-color

定制符号  
Customizable



头部防水IP67  
Waterproof IP67



配套专用插件  
Connector



镀金/银插脚/银触点  
Silver/Gold Pins/Contact



定制外壳颜色  
Custom Shell color

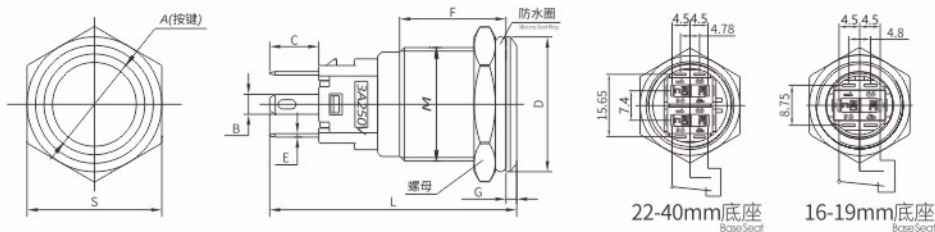

型号 Model	Size 尺寸	S	A	B	C	E	F	L	G	D	M	触点类型 Contact
LB16A	S19	Ø14	2.8	7	0.5	15	34.8	1.5	Ø19	M16X1	1NO1NC	
LB19A	S22	Ø17	2.8	7	0.5	15	34.8	1.5	Ø22	M19X1	1NO1NC	
LB22A	S25	Ø18	2.8	7	0.5	15	35	1.5	Ø25	M22X1	1NO1NC/2NO2NC	
LB25A	S28	Ø22	2.8	7	0.5	15	35	1.5	Ø28	M25X1	1NO1NC/2NO2NC	
LB28A	S31	Ø22	2.8	7	0.5	15	35	1.5	Ø31	M28X1	1NO1NC/2NO2NC	
LB30A	S34	Ø22	2.8	7	0.5	15	35	1.5	Ø33	M30X1	1NO1NC/2NO2NC	
LB40A	S45	Ø22	2.8	7	0.5	15	35	1.5	Ø43	M40X1	1NO1NC/2NO2NC	

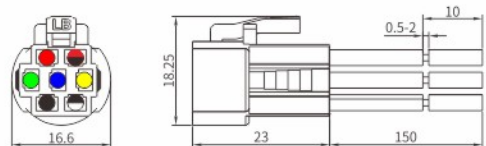

LB16A LB19A (1NO1NC)

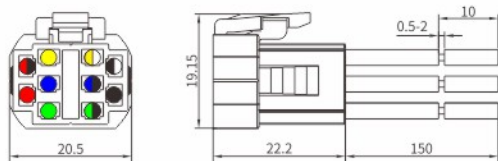

LB22A LB25A LB28A LB30A LB40A

●● 灯脚线 ●● 双色或三色灯脚线 ●● NC线 ●● NO线 ●● C脚进线

使用0.5mm<sup>2</sup>电线, 线长150mm, 可定做其他规格线长  
Wire Length: 150mm、0.5mm<sup>2</sup>, Customizable other Sizes



# LB19A1 Series

## 1NO1NC / 2NO2NC

Ith:5A 250VAC

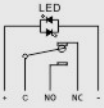

无灯 Without  
环形灯 Ring LED  
环形+电源 Ring+Power Symbol

红色 Red  
绿色 Green  
蓝色 Blue  
黄色 Yellow  
白色 White

低功耗LED: ≤20mA  
Low Power Consumption LED: ≤20mA  
常规电压: 5-24V 220V, 定制其它电压  
Normal Voltage: 5-24V 220V, Customizable Other Voltage  
常规颜色: 红色、绿色、蓝色; 定制: 黄色、白色  
Normal Color: Red/Green/Blue; Customizable: Yellow/White



**250VAC**  
高绝缘耐压  
High-Insulation



**<50mΩ**  
快动高灵敏  
Contactsensitive



**50000H**  
长寿命灯珠  
Long Life LED



**100万次**  
机械寿命  
Mechanical Life



**V2**  
耐温阻燃  
Anti Laming



**-40-80°C**  
环境耐温强  
Environment



**IP67/IK10**  
防水防爆  
Protection Level



**RoHS REACH CE TUV CE<sub>roHS</sub> CB<sub>roHS</sub>**  
专利及认证  
Certificate



可做2常开2常闭  
2NO2NC



专用插件,防误碰设计  
Connector

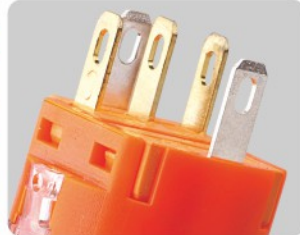

镀金银插脚,银触点  
Gold Pins/Silver Contact



头部防水,高亮LED  
Head Waterproof

4.5 4.5  
 7.1 15.2  
 33.4  
 0.5 2.8  
 21.8  
 15  
 S22  
 23  
 21.6  
 27 150  
 0.5-2 7

○●灯脚线    ●●NC线    ●●NO线    ●●C脚进线  
 使用0.5mm<sup>2</sup>电线,线长150mm,可定做其他规格线长  
 Wire Length: 150mm、0.5mm<sup>2</sup>, Customize their Sizes

# LB12B/16E Short 短款

## Short-Length Series

Ith:3A 250VAC

1NO



低功耗LED: ≤20mA

Low Power Consumption LED: ≤20mA

常规电压: 5-24V 220V, 定制其它电压

Normal Voltage: 5-24V 220V, Customizable Other Voltage

常规颜色: 红色、绿色、蓝色; 定制: 黄色、白色

Normal Color: Red/Green/Blue; Customizable: Yellow/White



头部及外壳可做氧化彩色  
Head and shell can be oxidized color



总长: 21.3mm

- 10 20**  
21.3mm 精致短款  
Delicate
- RGBY**  
彩色氧化头部  
Oxidized Color
- LED**  
50000H 长寿命灯珠  
Long Life LED
- 100万次**  
机械寿命  
Mechanical Life
- VO**  
耐高温阻燃  
Anti Flaming
- 40-80°C**  
环境耐温强  
Environment
- 定制1500VAC**  
高绝缘耐压  
High-Insulation
- CCC RoHS REACH CE**  
专利及认证  
Certificate



12mm

小巧精致, 可配接插件  
Small and Beautiful



16mm

自复/自锁-1NO  
Momentary/Latching-1NO



氧化彩色头部及外壳  
Can be oxidized color



柔和高亮LED, 长寿命  
Soft and bright Long-Life LED

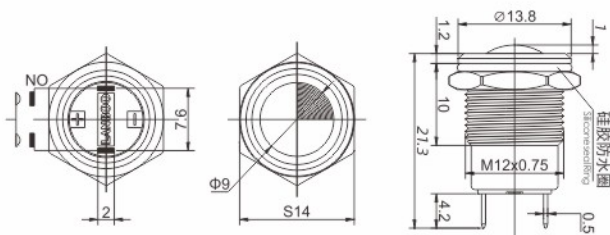

12B外形尺寸  
Outline Dimension

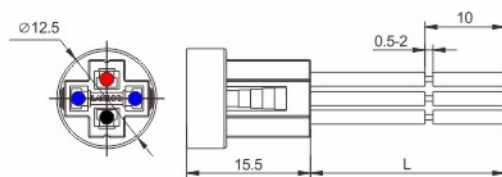

16E外形尺寸  
Outline Dimension

● 0.3mm<sup>2</sup> (NO)    ●● 0.3mm<sup>2</sup> (LED±)  
使用0.3mm<sup>2</sup>电线, 线长150mm, 可定做其他规格线长  
Wire Length: 150mm 0.3mm<sup>2</sup>, Customize other Sizes

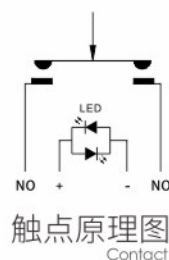

触点原理图  
Contact



# LB22B / 25B NEW 升级款

## 大电流金属按钮开关

High-Current Button

Ith:10A 250VAC

1NO1NC

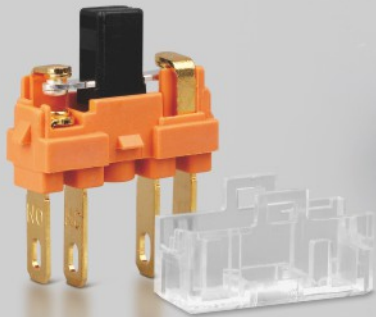

大电流微动开关  
High Current MicroSwitch

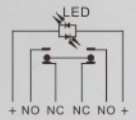

-   
**10A**  
 Ith  
 大电流开关  
 High-Current
-   
**2000VAC**  
 高绝缘耐压  
 High-Insulation
-   
**50000H**  
 长寿命灯珠  
 Long Life LED
-   
**100万次**  
 机械寿命  
 Mechanical Life
-   
**V2**  
 耐高温阻燃  
 Antif Laming
-   
**-40~80°C**  
 环境耐温强  
 Environment
-   
**IP67/IK10**  
 防水防爆  
 Protection Level
-   
**CCC RoHS REACH CE**  
 专利及认证  
 Certificate



可视化窗口,科技感十足  
Visual Window



镀金/镀银插脚,导电性好  
Silver/Gold Plated Pins

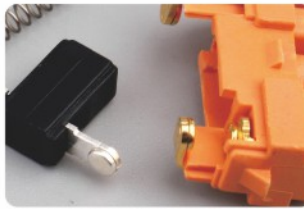

加粗触点,通过电流更大  
Big Contact



柔和高亮LED  
Soft And High Lighted LED

-   
 无灯  
 Without
-   
 环形灯  
 Ring LED
-   
 环形+电源  
 Power Symbol
-   
 红色  
 Red
-   
 绿色  
 Green
-   
 蓝色  
 Blue
-   
 黄色  
 Yellow
-   
 白色  
 White

低功耗LED: ≤20mA  
 Low Power Consumption LED: ≤20mA  
 常规电压: 9-24V 220V, 定制其它电压  
 Normal Voltage: 9-24V 220V, Customizable Other Voltage  
 常规颜色: 红色、绿色、蓝色; 定制: 黄色、白色  
 Normal Color: Red/Green/Blue; Customizable: Yellow/White

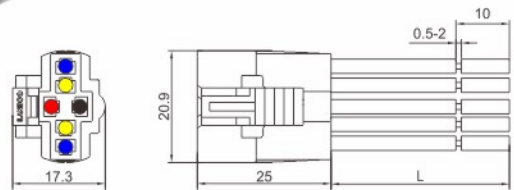
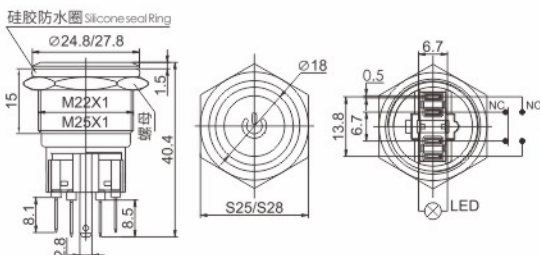

● 灯脚线 ● NC线 ● NO线  
 NC NO 使用1mm<sup>2</sup>电线, LED 0.5mm<sup>2</sup>电线,  
 线长150mm, 可定做其他规格线长  
 Wire Length: 150mm, NC NO : 1mm<sup>2</sup> wire,  
 LED: 0.5mm<sup>2</sup> wire, Customize other Sizes

# LB19/22CM TOUCH

1NO大电流双色触摸开关

1NO High-Current Bi-color Touch Switch

Ith:5A 250VAC

IP68



环形灯  
Ring LED



环形+电源  
Ring+Power Symbol

通电蓝色发光/触摸红色发光

Power on-Blue/Touch Button-Red

LED长寿命 | 双色指示 | 灯光柔和

LED High Durability | Bi-Color | Light soft

输入电压:DC12V DC24V

Input Voltage



5A

Ith

大电流开关

High-Current



RB

红蓝双色指示

Bi-Color



LED

50000H

长寿命灯珠

Long Life LED



10万次

机械寿命

Mechanical Life



V2

耐温阻燃

Anti-flaming



-40-80°C

环境耐温强

Environment



IP68/IPK10

防水防爆

Protection Level



CCC RoHS REACH

专利及认证

Certificate



专用插件,卡扣设计  
Connector



1NO 镀金插脚  
1NO Gold-Plated Pins



4芯护套线  
4 Core Sheath Wire



氧化黑/不锈钢  
Oxidation Black/Stainless Steel

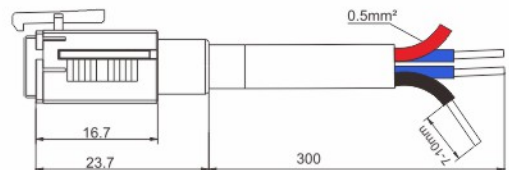
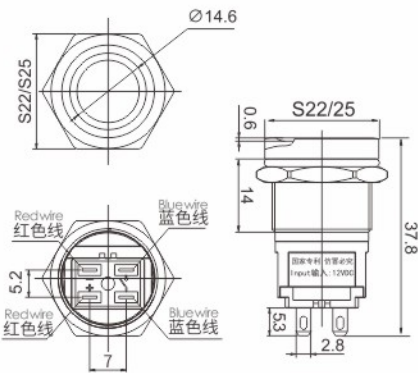

●● LED灯及工作电压输入线 ● NO线 (通电默认断开, 触摸后导通, 无源信号)

使用0.5mm<sup>2</sup>护套线, 线长300mm, 可定做其他规格线长  
Wire Length:300mm、0.5mm<sup>2</sup>,Customize other Sizes



# LB12-22QC Pins 插脚款

Ultra-thin Tact Metal Buttons  
超薄款轻触金属开关

Ith:0.5A 250VAC

1NO



低功耗LED: ≤20mA  
Low Power Consumption LED ≤20mA  
常规电压: 5-24V 220V, 定制其它电压  
Normal Voltage: 5-24V 220V, Customizable Other Voltage  
常规颜色: 红色、绿色、蓝色; 定制: 黄色、白色  
Normal Color: Red / Green / Blue; Customizable: Yellow / White



15mm  
超短款  
Short



IP68/K08  
防水防爆  
Protection Level



50000H  
长寿命灯珠  
Long Life LED



10万次  
机械寿命  
Mechanical Life



V0  
耐温阻燃  
Antiflaming



-40-80°C  
环境耐温强  
Environment



3.5N  
按压手感好  
Convenient press



CCC RoHS REACH CE  
专利及认证  
Certificate



不锈钢外壳  
Stainless Steel Shell



请认准“LANBOO”  
LANBOO Button



柔和高亮LED, 寿命达50000小时  
Momentary With LED



头部防水高达IP68  
Head waterproof IP68

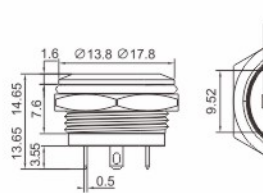

LB12/16QC

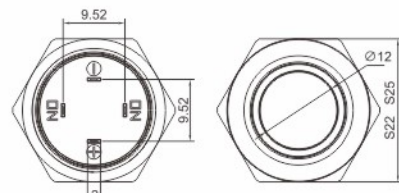
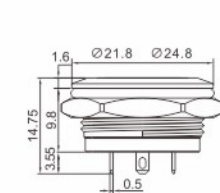
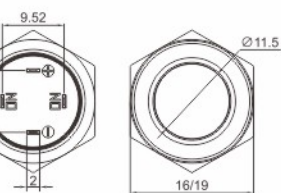

LB19QC LB22QC



蓝波新款

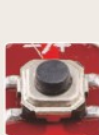

为了提升手感、按压行程、按压声音.....  
蓝波工程师为了寻找这颗满意的轻触开关,寻找多家优秀轻触开关厂家还进行无数次的测试。

**优点:**  
1. 独立轻触开关, PCB焊接式, 性能更稳定。  
2. 行程略长, 按压手感更好, 有明显按压手感回馈。  
3. 声音清脆, 有微动开关的感觉。  
4. 接触电阻降低, 符合国家标准。



**4颗无极长寿命LED灯珠**  
采用进口LED无极芯片, 采用全自动贴片焊接。

**优点:**  
1. 无极LED, 不分正负极, 接线方便省事。  
2. 进口LED芯片, 亮度高, 寿命长, 色温一致性高。  
3. 4颗LED, 整体发光更均匀。  
4. 蓝波拥有全自动贴片, 焊点更美观牢固, 无虚焊。

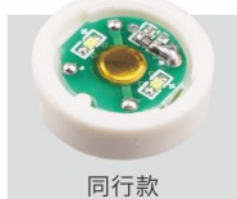

同行款



**市场款导通部件**  
胶布粘合固定的不锈钢仔片, 有胶布老化导致脱落, 贴歪偏心导致接触不良等.....

**缺点:**  
1. 胶布粘合, 容易老化导致脱落、移位...。  
2. 按了没按一样, 无明显手感反馈, 手感无。  
3. 电阻大或位置不准造成失灵风险。



**2颗分正负极的小灯珠**  
接线需分辨正负极, 手工焊接....

**缺点:**  
1. 接线需找正负极, 正负容易接反, 浪费时间。  
2. 两颗微型灯珠, 发光扩散不均匀。  
3. 手工焊锡, 容易粘连、虚焊, 可靠性差。  
4. ....

# LB16NZ Toggle Switch 钮子开关

Ith:20A/250VAC

1NO1NC

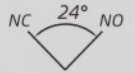

环形灯  
RingLED



红色  
Red



绿色  
Green



蓝色  
Blue



黄色  
Yellow



白色  
White

低功耗LED: ≤20mA

Low Power Consumption LED: ≤20mA

常规电压: 5-24V 220V, 定制其它电压

Normal Voltage: 5-24V 220V, Customizable Other Voltage

常规颜色: 红色、绿色; 定制: 黄色、白色、蓝色

Normal Color: Red/ Green; Customizable: Yellow/White/Blue



Ith:20A  
大电流开关  
High-Current



大手柄  
档位清晰  
Big Handle



50000H  
长寿命灯珠  
Long Life LED



50万次  
机械寿命  
Mechanical Life



VO  
耐温阻燃  
Anti-laminating



-40-80°C  
耐温性能强  
Environment



CCC RoHS REACH CE  
专利及认证  
Certificate

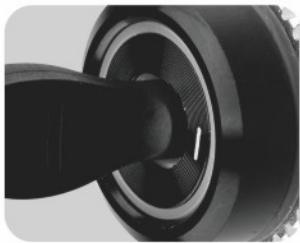

大手柄, 头部CD纹设计  
Big handle, Easy Operation

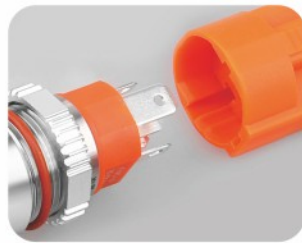

可配专用插件  
Connector



银触点, 加粗银插脚  
Big Silver Pins



带灯指示  
LED

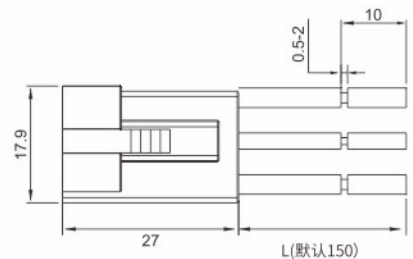
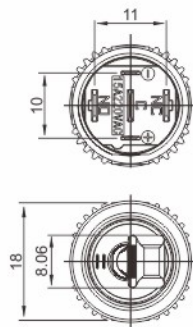
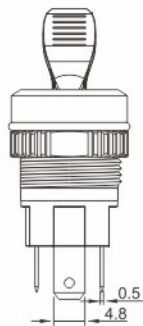
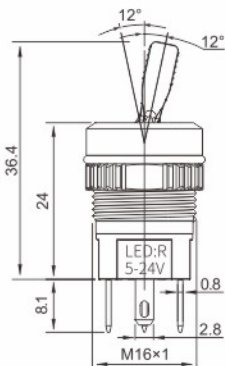

● 灯脚线 ● NC线 ● NO线 ● C脚进线  
● 0.5mm<sup>2</sup>, ● 1.5mm<sup>2</sup>,  
线长150mm, 可定做其他规格线长  
Wire Length: 150mm, Customize other Sizes



# LB19/ 22X5 Knob 旋钮

新款带灯 1NO1NC/2NO2NC

Ith:5A 250VAC

IP65

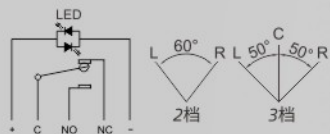

D型限位槽安装  
D Locating Slot



低功耗LED: ≤20mA

Low Power Consumption LED: ≤20mA

常规电压: 5-24V 220V, 定制其它电压

Normal Voltage: 5-24V 220V, Customizable Other Voltage

常规颜色: 红色、绿色; 定制: 蓝色、黄色、白色

Normal Color: Red / Green; Customizable: Blue / Yellow / White



大旋柄  
手感更好  
Big handle



50000H  
长寿命灯珠  
Long Life LED



25万次  
机械寿命  
Mechanical Life



H65  
镀金/银插脚  
Gold Plated/Silver Pins



V2  
耐温阻燃  
Antiflaming



-40~80°C  
耐温性能强  
Environment



CCC RoHS REACH CE  
专利及认证  
Certificate



带灯,大旋柄  
LED, Big Handle



专用插件,防误碰设计  
Connector



镀金银插脚,银触点  
Gold Plated Pins/Silver Contact



头部防水,高亮LED  
IP65, With LED

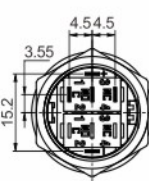
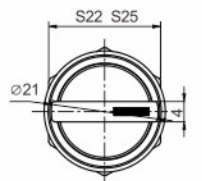

19mm 22mm

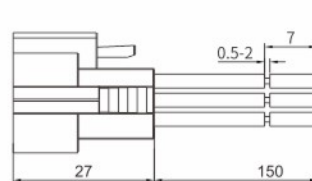
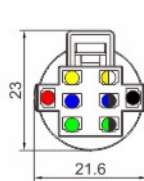
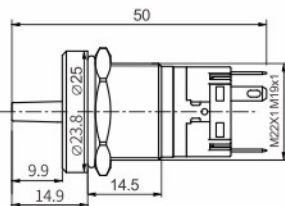

● 灯脚线 ● NC线 ● NO线 ● C脚进线

使用0.5mm<sup>2</sup>电线, 线长150mm, 可定做其他规格线长  
Wire Length: 150mm, 0.5mm<sup>2</sup>, Customize other Sizes

# LB19 / 22Y5 KeySwitch 钥匙钮

新款带灯 1NO1NC/2NO2NC

Ith:5A 250VAC

IP65



D型限位槽安装  
D Locating slot



低功耗LED: ≤20mA

Low Power Consumption LED: ≤20mA

常规电压: 5-24V 220V, 定制其它电压

Normal Voltage: 5-24V 220V, Customizable Other Voltage

常规颜色: 红色、绿色; 定制: 蓝色、黄色、白色

Normal Color: Red / Green; Customizable: Blue / Yellow / White



迷你柄  
方便操作  
MINI Handle



50000H  
长寿命灯珠  
Long Life LED



20万次  
机械寿命  
Mechanical Life



H65  
镀金/银插脚  
Gold Plated/Silver Pins



V2  
阻燃  
AntiFlaming



-40~80°C  
耐温性能强  
Environment



CCC RoHS REACH CE  
专利及认证  
Certificate



皮革纹路手柄, 手感好  
Feel Good

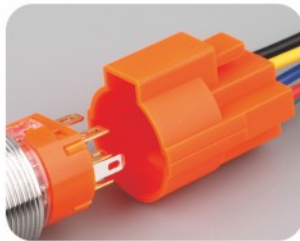

可配专用插件  
Connector



镀金银插脚, 银触点  
Gold Plated Pins/Silver Contact



带灯指示  
LED

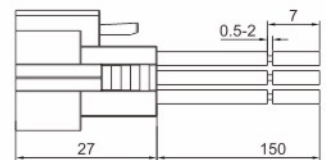
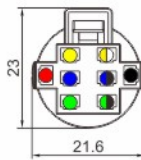
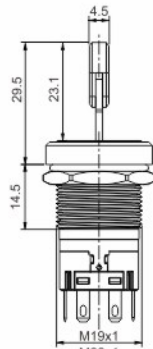
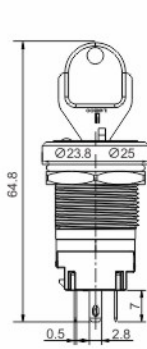
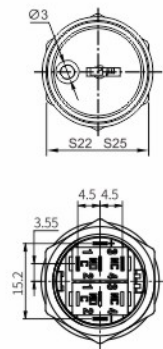

● 灯脚线 ● NC线 ● NO线 ● C脚进线

使用0.5mm<sup>2</sup>电线, 线长150mm, 可定做其他规格线长  
Wire Length: 150mm, 0.5mm<sup>2</sup>, Customize other Sizes



# LBM4 / M5.4 Series

防水带灯系列急停按钮  
Emergency Stop button with LED

16/19/22mm  
Ith:5A 250VAC

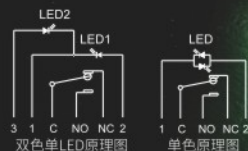

M4可做双色, 比如通电绿色, 按下红色

M4 Power on-Green LED, Push down button-Red LED

M5系列可达IP67, M4可定制IP65

M5 Series IP67, M4 can be customized IP65

低功耗LED: ≤20mA

Low Power Consumption LED: <20mA

常规电压: 5-24V 220V, 定制其它电压

Normal Voltage: 5-24V 220V, Customizable Other Voltage

常规颜色: 红色、绿色; 定制: 蓝色、黄色、白色、M4红绿双色

Normal Color: Red / Green; Customizable: blue / Yellow / White / M4 Red-Green Bi-color



RG

M4可做双色  
M4 Bi-Color



2500VAC

M5绝缘耐压  
High-Insulation



50000H

长寿命灯珠  
Long Life LED



25万次

机械寿命  
Mechanical Life



V2

耐温阻燃  
Anti Flaming



-40~80°C

环境耐温强  
Environment



IP65/IK10

M5防水防爆  
Protection Level



CCC RoHS REACH CE

专利及认证  
Certificate



红绿双色指示、防滑边缘  
Red-Green Bi-color



D型限位槽设计  
"D" Locating Slot



镀金插脚, 银触点  
Gold Plated Pins / Silver Contact

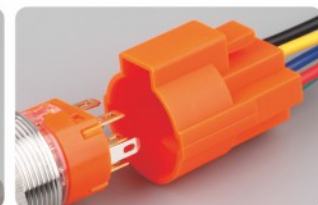

专用接插件  
Connector

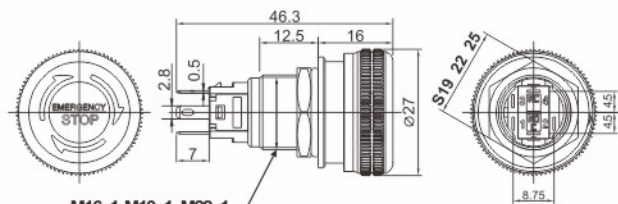

M16x1 M19x1 M22x1

16/19/22M4急停  
16/19/22M4 Stop Button

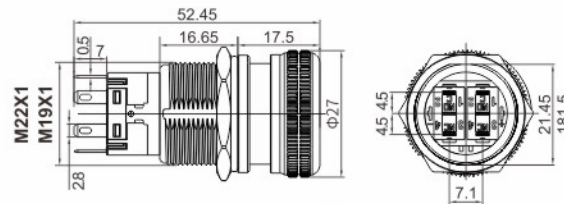

19M5.4 22M5.4急停  
19/22M5.4 Stop Button

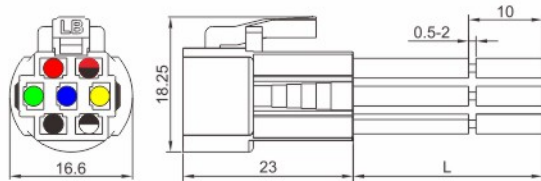

16M4 16A-M11专用接插件  
Connector

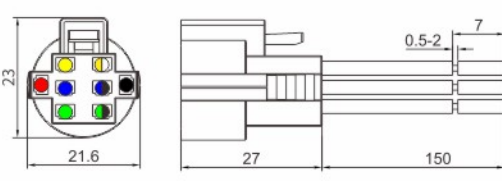

M5.1 M5.2 M5.4专用接插件  
Connector

●● 灯脚线 ●● 双色灯脚线 ●● NC线 ●● NO线 ●● C脚进线

使用0.5mm<sup>2</sup>电线, 线长150mm, 可定做其他规格线长  
Wire Length: 150mm 0.5mm<sup>2</sup>, Customize other Sizes



# 急停系列

## STOP Series

### 16 / 19 / 22mm



LB22M3  
8A大电流  
High Current

LB16SM(IP65)

镀金脚 Gold-Plated Pins

阻燃外壳 Retardant shell

防滑 Antiskid

LBM5.2(IP67)

LBM5.1(IP67)

LB16A-M11

LB16SM2(IP65)

LBM6



铝氧化加大头部, 手感好  
Aluminum Oxide Red



D型限位槽设计  
"D" Locating Slot



镀金插脚, 银触点  
Gold Plated Pins/Silver Contact

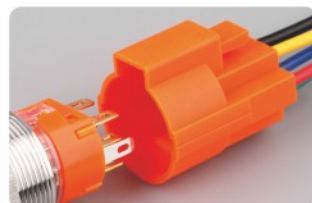

专用接插件  
Connector

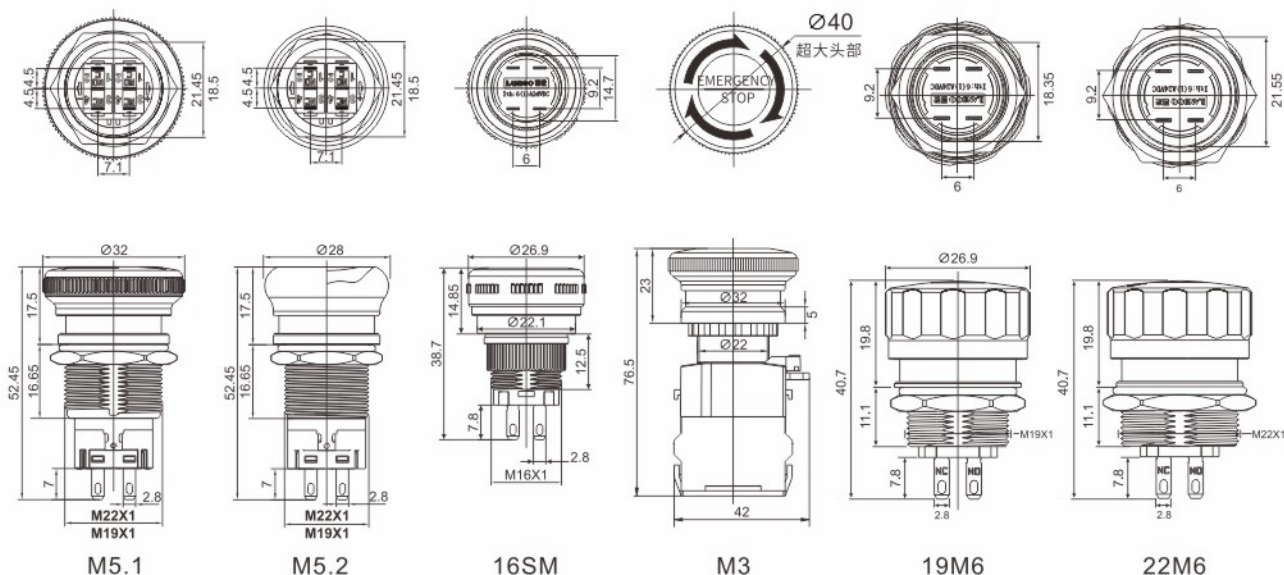



# LB6-25Z 信号灯

## Indicator Light

### IP68



6-12mm: IP40/其中10/12mm可做双色9-24V 220V  
 6-12mm: IP40, 10/12mm Bi-color/9-24V 220V  
 16-25mm: IP68/螺丝脚款可做双色三色/5-24V 220V  
 16-25mm: IP68/Screw pins Bi-color, Tri-color/5-24V 220V

- RGB**  
可做双色三色  
Bi-Color Tri-Color
- 灯光高亮 大发光面**  
Whole Facelight
- LED**  
50000H  
长寿命灯珠  
Long Life LED
- < 20mA**  
低功耗  
Low-Power
- V0**  
耐温阻燃  
Anti Laming
- 40~80°C**  
环境耐温强  
Environment
- IP68/IK10**  
防水防爆  
Protection Level
- CCC RoHS REACH CE**  
专利及认证  
Certificate



6-12mm 亚光面发光  
Matte Surface



16-25mm 亮面大发光面  
Bright Glowing



16-25mm 螺丝脚款可做双色三色  
Screw Pins/Bi-Color/Tri-Color

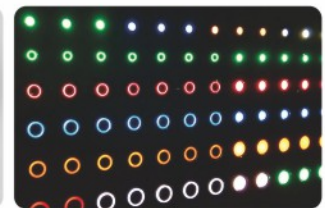

五颜六色, 灯光明亮  
Multicoloured

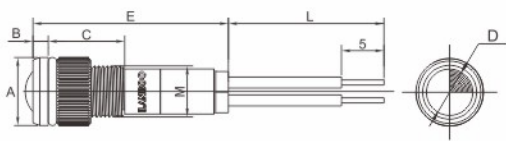

6~12mm 0.15mm<sup>2</sup>铜芯线  
Copper core wire

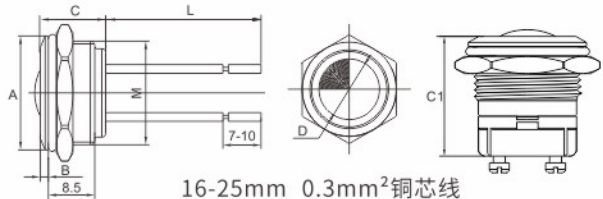

16-25mm 0.3mm<sup>2</sup>铜芯线  
Copper core wire

直径 Diameter	A	B	C	D	E	L
6mm	Ø8	1.8	9	Ø5.5	23	150
8mm	Ø10	1.8	10	Ø5.5	23.6	150
10mm	Ø12	1.8	11	Ø8	23.6	150
12mm	Ø14	1.8	11	Ø8	23.6	150

直径 Diameter	A	B	C	C1	D	L
16mm	Ø17.8	1.5	12	18	Ø11.5	150
19mm	Ø20.9	1.5	12	18	Ø11.5	150
22mm	Ø24.8	2	13	18	Ø18	150
25mm	Ø27.9	2	13	18	Ø18	150

# LB8A 高亮信号灯

## Highlight Indicator Light

# IP68



低功耗LED:  $\leq 20\text{mA}$   
 Low Power Consumption LED  
 常规电压: 5-24V 220V, 定制其它电压  
 Normal Voltage: 5-24V 220V, Customizable Other Voltage



- 灯光高亮 大发光面  
Whole Face Light
- 72° 透镜聚光  
Optical lens Spotlight
- LED 50000H 长寿命灯珠  
Long Life LED
- $< 20\text{mA}$  低功耗  
Low power Consumption
- V2 耐阻燃  
Anti-laminating
- $-40-80^{\circ}\text{C}$  环境耐温强  
Environment
- IP68/IK10 防水防爆  
Protection Level
- CCC RoHS REACH CE 专利及认证  
Certificate



小巧精致  
Delicate



专用接插件  
Connector



透镜聚光好  
Optical lens Spotlight



五颜六色, 灯光明亮  
Multicoloured

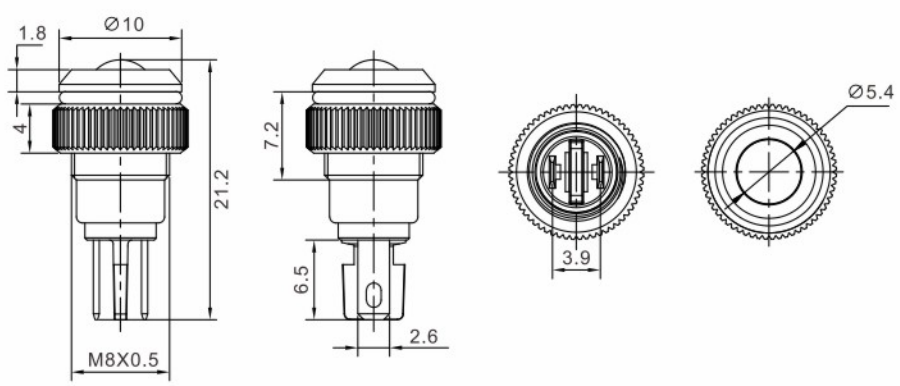



# LBFMQ 蜂鸣器

ACOUSTO-OPTIC BUZZER SERIES

金属头部/阻燃外壳

Metal head/Retardant shell

70~100dB/5cm

DC 12V/24V/AC220V

IP65



70-100dB  
蜂鸣响亮  
Sonority



0.5S  
0.5S间隙闪烁  
Clearance Flashing



10000H  
持续通电1万小时  
Continuous Electricity



IP68/IK10  
防水防尘  
Protection Level



V2  
耐高温阻燃  
Anti Laminating



-40-80°C  
耐温性能强  
Environment



CCC RoHS REACH CE  
专利及认证  
Certificate



304金属面罩、IP65  
304 Stainless Steel, IP65



球头发光角度更大  
Ball head



螺丝脚方便接线  
Screw Pins



高亮闪烁灯光  
70dB/LED

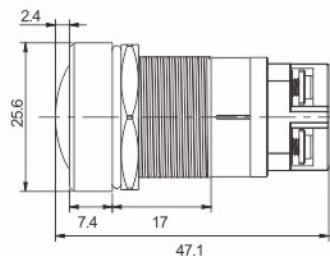
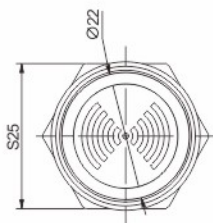
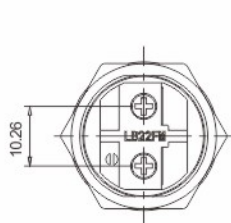

# 2系列经济款

2 Series economical models

12B2 16A2 19A1.2 22B2 25B2

12B2金属按钮开关 Metal Button Switch



16A2金属按钮开关 Metal Button Switch



19A1.2金属按钮开关



22B2 25B2金属按钮开关





# LB16SA Series

## 新品-塑料按钮开关

Flame Retardant Plastic Switch

高亮面材质 Bright surface

### 1N01NC



整面发光  
Bright Surface



红色 Red    绿色 Green    蓝色 Blue    黄色 Yellow    白色 White

低功耗LED:  $\leq 20\text{mA}$

Low Power Consumption LED:  $\leq 20\text{mA}$

常规电压: 9-24V 220V, 定制其它电压

Normal Voltage: 9-24V 220V, Customizable Other Voltage

常规颜色: 红色、绿色、蓝色; 定制: 黄色、白色

Normal Color: Red/Green/Blue; Customizable: Yellow/White

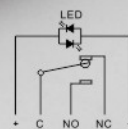

12.4mm

大发光面  
Whole Face LED



5000VAC

高绝缘耐压  
High-Insulation



50000H

长寿命灯珠  
Long Life LED



20万次

机械寿命  
Mechanical Life



V0

耐高温阻燃  
AntiFlaming



-40~80°C

环境耐温强  
Environment



IP65

防尘防溅水  
Protection Level



CCC RoHS REACH CE TUV CE CB

专利及认证  
Certificate



发光面积大, 灯光柔和  
Whole Face LED



专用接插件, 镀银插脚  
Connector Silver Plated Pins



按键凹面设计, 防滑螺母  
Non-Slip nuts

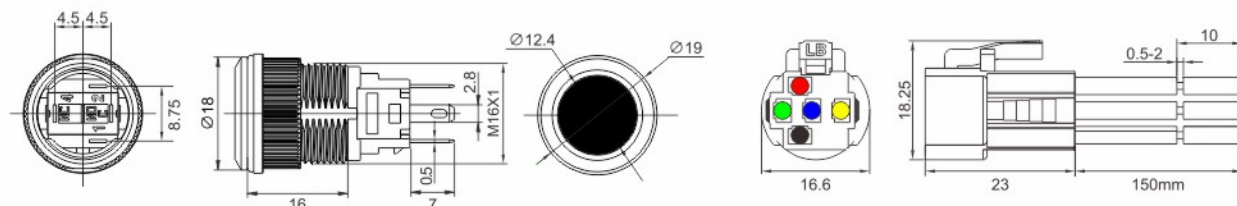

● LED灯脚

● Nc常闭脚    ● No常开脚    ● C公共进线脚

0.5mm<sup>2</sup>电线, 长150mm, 可定做其他规格线长  
Wire Length: 150mm 0.5mm<sup>2</sup>, Customize other Sizes

# 定制开发系列

Custom Development Series

优秀的研发团队, 可根据您的需求量身定制各种开关  
Excellent R&D team, can be customized according to your needs of various switches

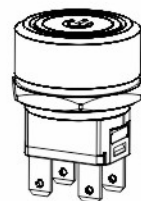
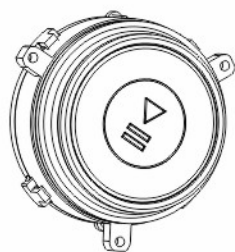

某机器人公司定制  
Customized by Robot Company

格力电器定制  
Custom made by Gree Electric



## 定制符号及外壳系列

CUSTOMIZABLE ARBITRARY SYMBOL





# LBS1 Series

锌合金槽型光电开关  
Zinc Alloy  
Sensor Switch

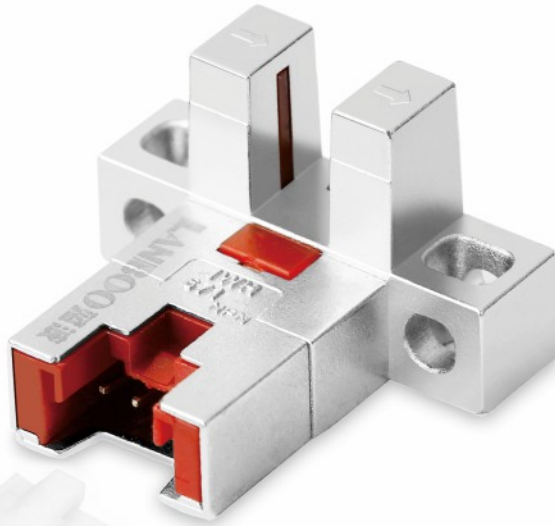

- |   |  |  |   |  |
|---|--|--|---|--|
| <br><b>Zinc</b><br>锌合金外壳<br>Zinc Alloy Shell | <br><b>100m/S<sup>2</sup></b><br>抗震抗压<br>Anti-Vibration | <br><b>EWI</b><br>屏蔽干扰<br>Shield             | <br><b>90%</b><br>维护成本降90%<br>Easy Maintenance | <br><b>3000Hz</b><br>响应精度高<br>High Precision    |
| <br><b>5-24VDC</b><br>宽电压<br>Wide Voltage  | <br><b>NO/NC</b><br>常开常闭<br>Open/Close                | <br><b>H65</b><br>镀金插脚<br>Gold Plated pins | <br><b>-25~55℃</b><br>环境耐温强<br>Environment   | <br><b>RoHS REACH</b><br>专利及认证<br>Certificate |

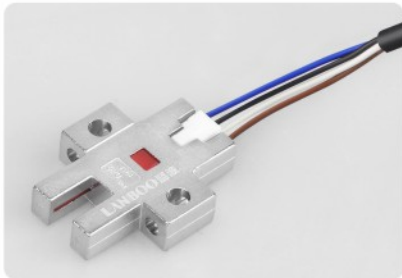

LBS1-OCH/1/8(E-SX670)

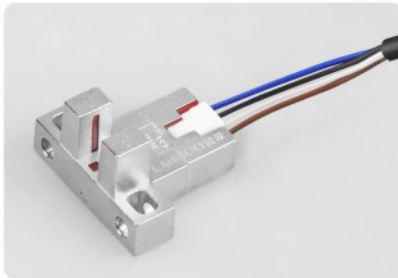

LBS1-OCL/1/8(E-SX671)

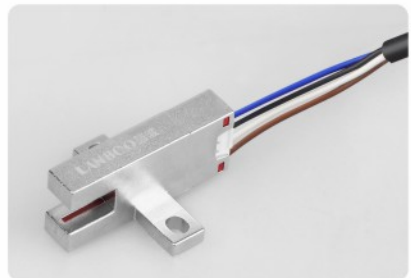

LBS1-OCT/1/8(E-SX672)

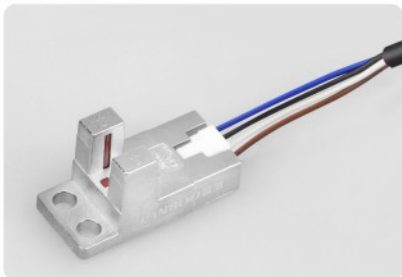

LBS1-OCLJ/1/8(E-SX674)

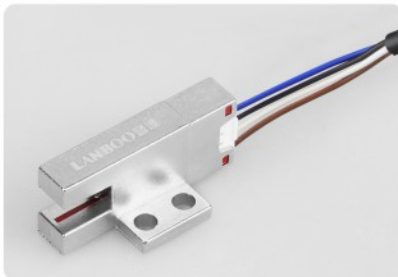

LBS1-OCF/1/8(E-SX676)

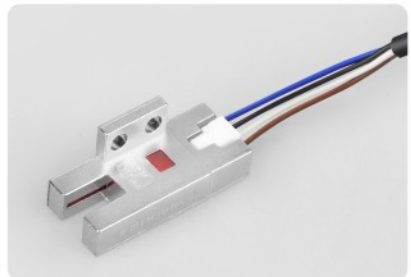

LBS1-OCR/1/8(E-SX677)

# LB22SA1

高端快插式按钮开关、指示灯  
Push Button、Indicator Light

## 彻底改变传统接线

Completely change the traditional wiring

# Fast Connection



1S  
秒插接线



Ui:660V  
Ith:25A



22mm  
开孔直径



50000H  
长寿命LED



≥50 万次电气寿命  
≥1000 万次机械寿命



# LB22SA1

Push Button、Indicator Light  
高端按钮开关、信号灯

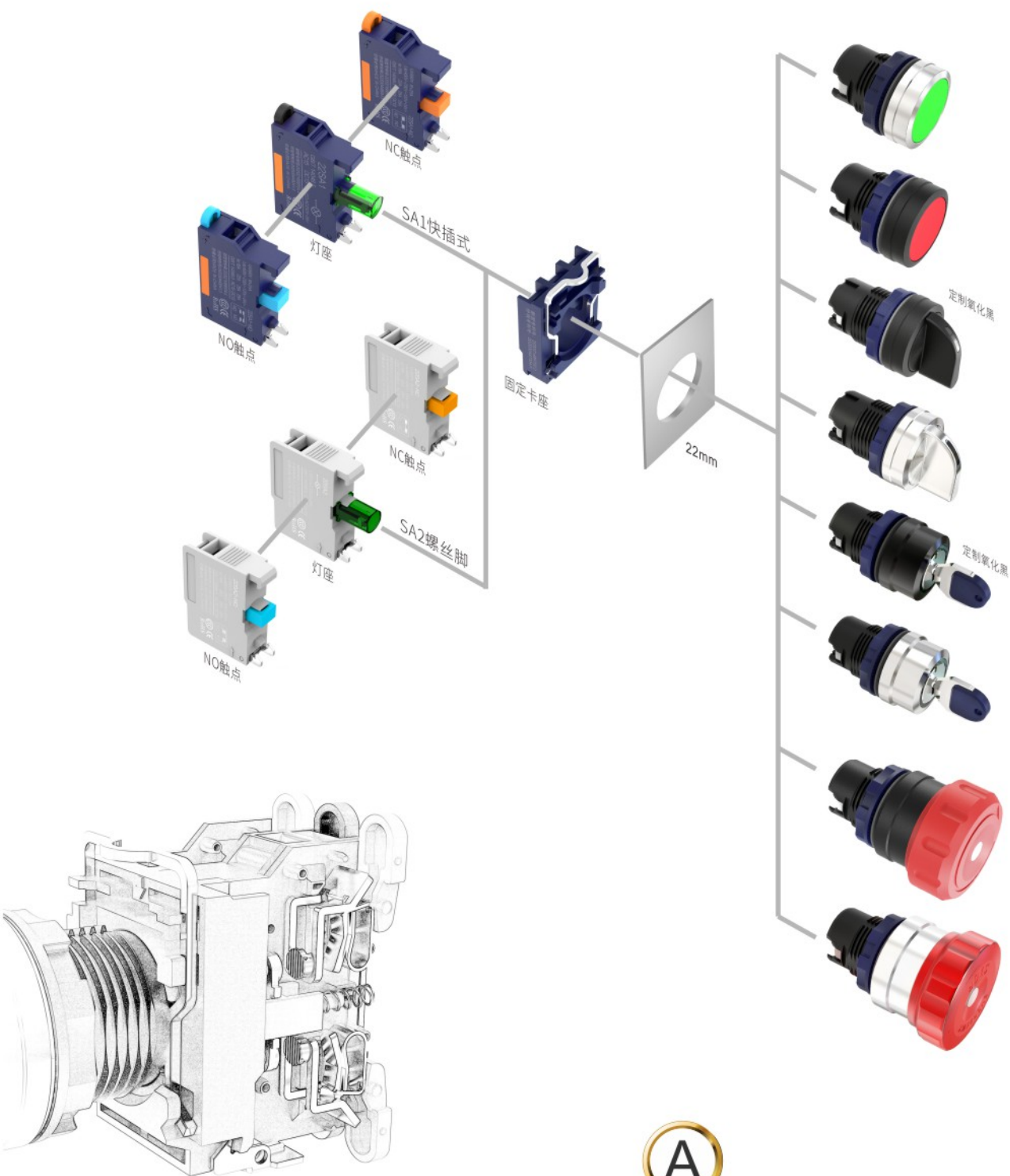

Current 25A大电流  
High-Current

## 大电流再次突破

Ui:660V/Ith:25A,直接控制大功率设备

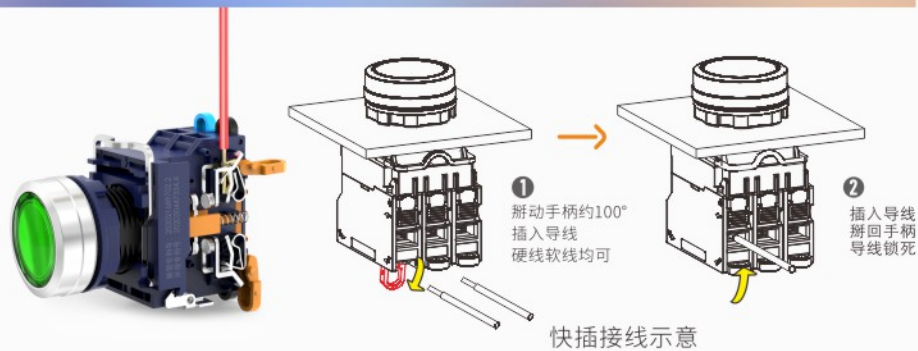

IP65 IK08



→ Ith:25A  
慢动双银点  
Silver Contact



→ 3500VAC  
工频耐压  
Rated impulse  
withstand voltage



→ 10000000  
次机械寿命  
Mechanical life



→ 1S  
秒插接线  
Second patch cord



→ 80N  
正向拉力  
电线无脱落  
Wire locking strength

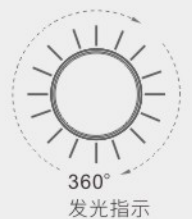
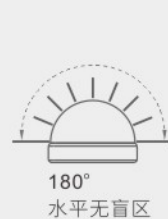

360° 发光

大球面高亮发光  
安全再次升级

Large sphere highlighting  
Security upgrade again





# LB22SA1

## 高端快插式按钮开关、指示灯

Plastic Push Button、Indicator Light

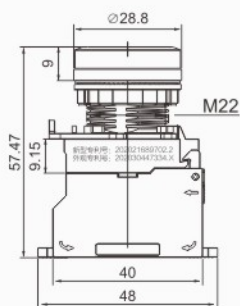

无灯复位款

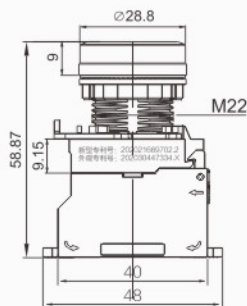

带灯自锁/自复  
无灯自锁款

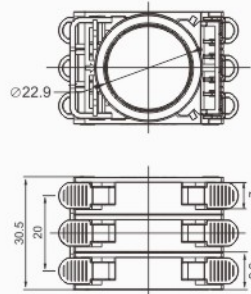
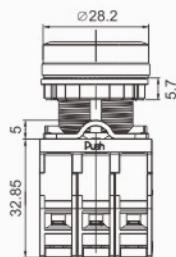

所有触点模块尺寸相同

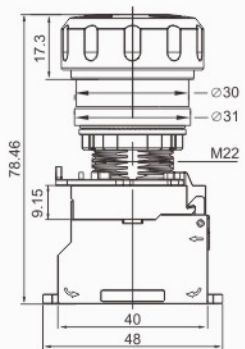

M1急停(塑料红色头部)

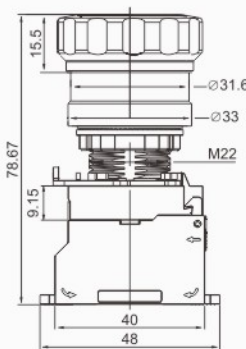
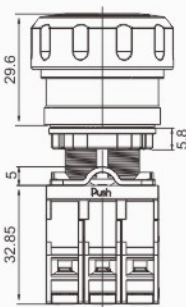

M3急停(铝氧化红色头部)

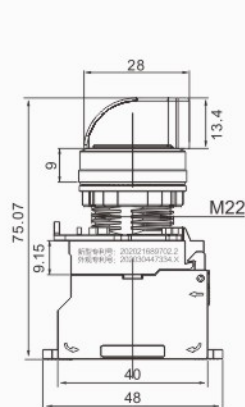
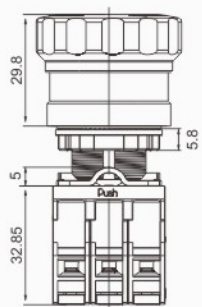

旋钮

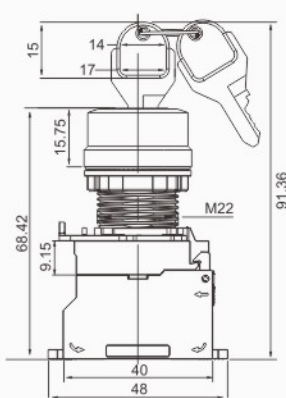
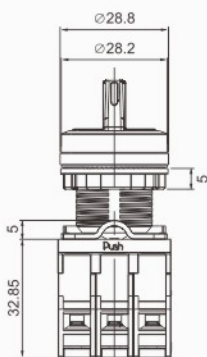

钥匙钮

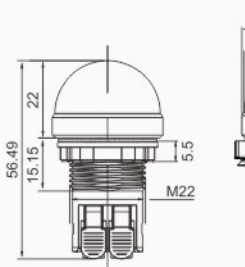
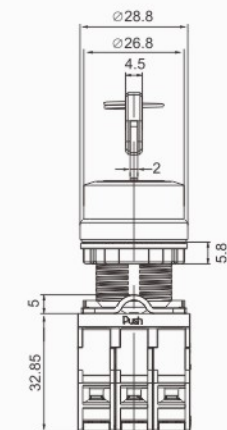

球头指示灯

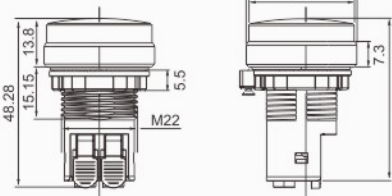
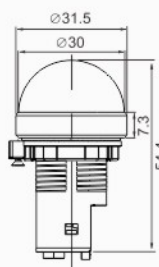

平头指示灯

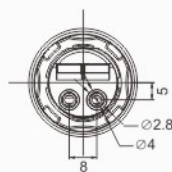

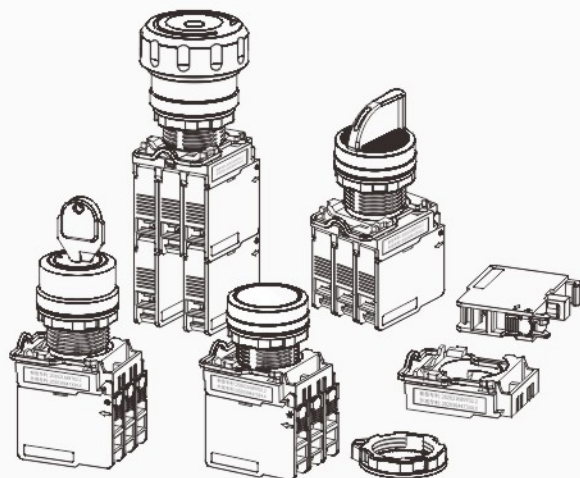

-   
 3NO3NC...  
 多触点组合
-   
 25A  
 U<sub>i</sub>:660V  
 I<sub>th</sub>:25A
-   
 22mm  
 开孔直径
-   
 LED  
 50000H  
 长寿命LED
-   
 ≥50 万次电气寿命  
 ≥1000 万次机械寿命

# LB22SA2

多触点组合式按钮开关、指示灯







IP65  
IK08



lth:25A  
慢动双银点  
Silver Contact



→ ≤ 4.5mm  
急停安装最  
大面板厚度  
Emergency stop  
Installation



→ 3500VAC  
工频耐压  
Rated impulse  
Withstand voltage



→ 10000000  
次机械寿命  
Mechanical life



→ ≥ 200N  
头部与中座  
间防脱落顶力  
Head and middle



→ > 50000h  
五万小时寿命  
无极灯珠  
Electrodeless Lamp  
Beads

← 金属头  
自锁



凹面设计, 贴合手指  
手感更舒适



↑  
1NC  
慢动  
双触点

↑  
灯座  
220V  
红色发光



PA66



铝氧化色

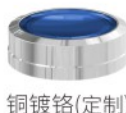

铜镀铬(定制)



不锈钢(定制)

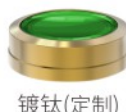

镀钛(定制)

上图型号示例

LB22SA2-P1CZ/R220V/A



可定制黑色  
旋柄+铝氧化  
化本色头部



可定制黑色  
旋柄+铝氧化  
化黑色头部



可定制氧化  
黑色头部

# LB22SA2

## 高端快插式按钮开关、指示灯

Plastic Push Button、Indicator Light



LB22SA2-P ◆■/PC

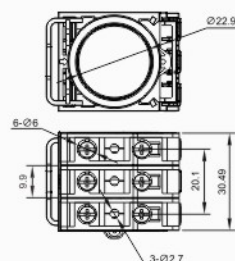
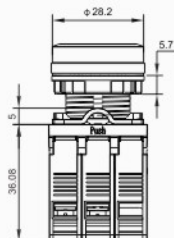
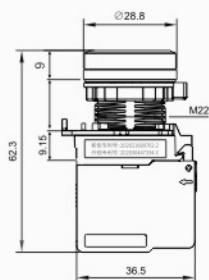

LB22SA2X1-X ◆■/A (银色)

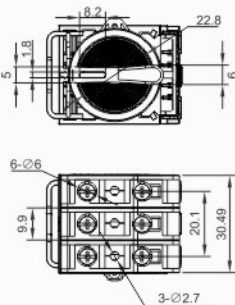
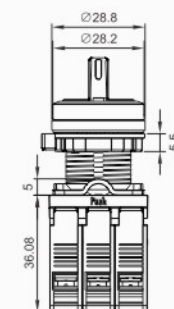
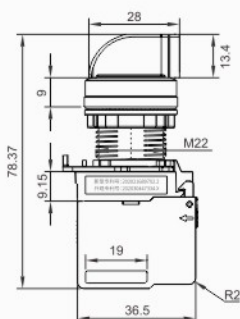

LB22SA2Y1-Y ◆■/A

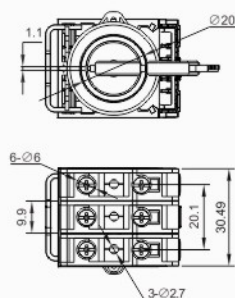
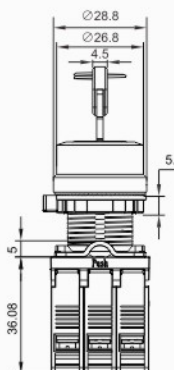
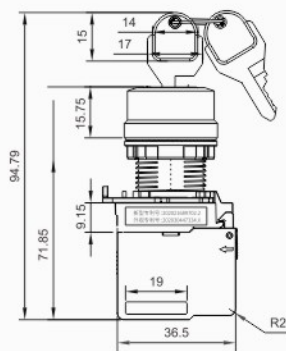

M1急停(塑料头部)  
LB22SA2M1-M ◆■/PC

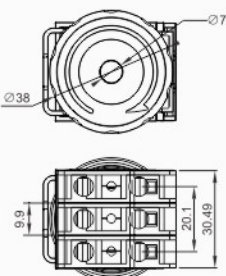
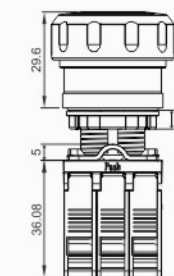
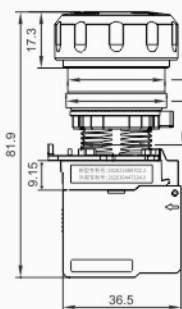

M3急停(铝氧化头部)  
LB22SA2M3-M ◆■/A

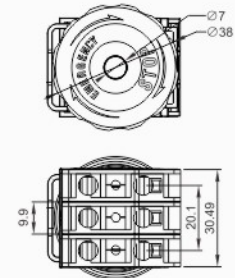
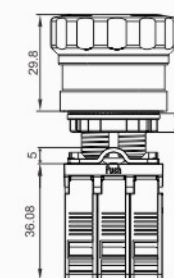
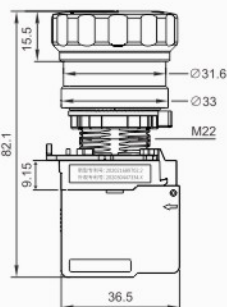



# LBφFW-J1-1.1

Emergency Stop Protective Cover

急停防误保护罩

Ø16mm Ø19mm Ø22mm



Quality Material  
好材质



Safe Care  
安全防护



Easy Installation  
使用方便



Quality Guarantee  
高品质

## 材质:ABS

外壳工艺:亚光黄色/灰色磨砂喷漆

适用孔径:16mm 19mm 22mm

Shell process:Matte yellow/gray frosted paint

Apply the aperture:16mm,19mm,22mm

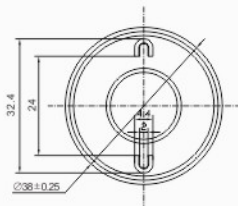

LB16FW-J1-1.1

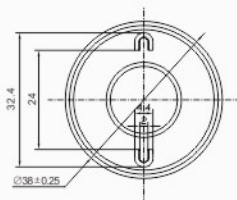

LB19FW-J1-1.1

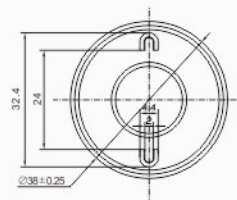

LB22FW-J1-1.1

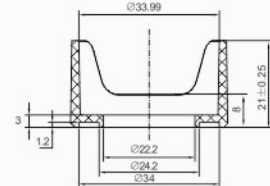
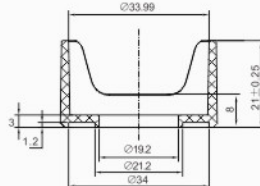
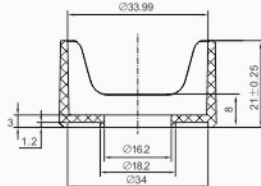

# LBBS Nutwrench 螺母扳手

12mm 16mm 19mm 22mm

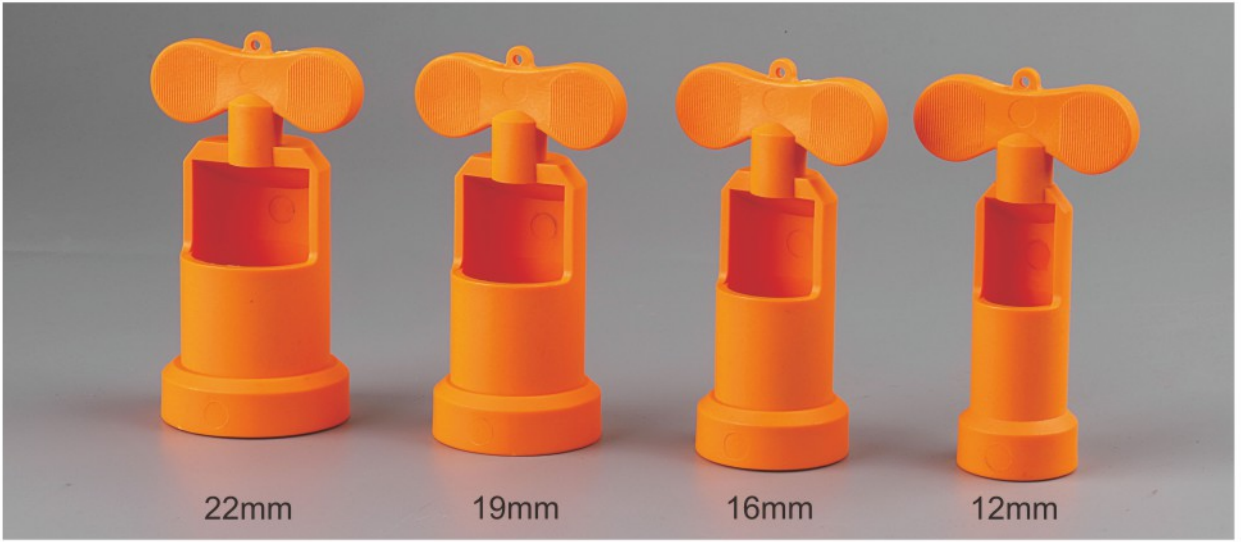

22mm

19mm

16mm

12mm

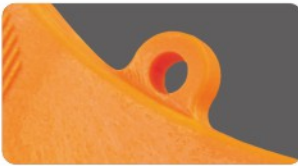

穿绳孔设计,避免遗失  
Avoid Missing



防滑设计,出汗都不怕  
Antuskid



加厚边缘,不爆边  
Thicken Edge



出线口设计,焊线了也不怕  
Outlet

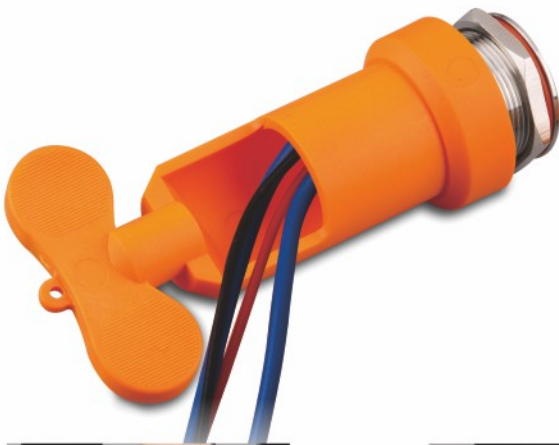

还这样拧?不仅费劲还伤手  
Difficulty, Hurts hand



强烈推荐  
Recommend



老板!还是这样好用哦  
Boss! I want this



# LBFW Anti Misoperation Cover 防误操作盖

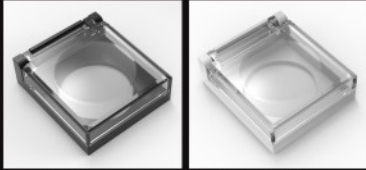

黑色款/Black 银色喷漆款/Silver

12mm / LB12FW-A1



16mm / LB16FW-A1

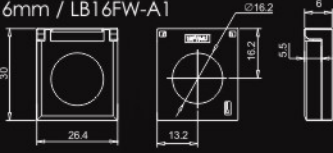

19mm / LB19FW-A1



22mm / LB22FW-A1



25mm / LB25FW-A1



LBØFW-1



LBØFW-2



LBØFSG



防水罩/16mm 19mm 22mm  
Waterproof

硅胶材质, 耐用耐腐蚀  
Silicone Waterproof

# ● 中国·蓝波智能科技有限公司

LANBOO INTELLIGENT TECHNOLOGY CO.,LTD

📍 中国·浙江省乐清市城东街道永兴二路12号  
No.12,Yongxin 2 Road,Chengdong Street,YueQing City,ZheJiang province,China

☎ 0577-62385330 (温州总公司)

☎ 0577-62385332

🌐 lanbodg.tmall.com

📞 销售:13165850065 (微信)

📞 售后:15372868655 (微信)

🌐 nan-bo.com

lanboo.vip

随着时间不断推移,技术不断的更新,若有更改恕不另行通知,产品图片若与实物有差别,请以实物为准,本公司保留最终解释权!未经允许请勿转载翻印,版权归蓝波所有.